

P01-P15

硬灯条/线条灯

铝型材套件

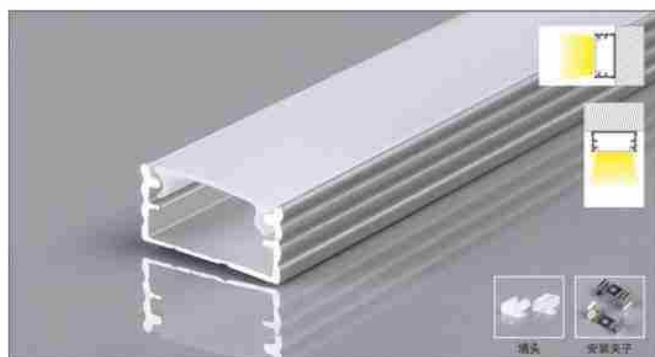

XT45

产品参数 **1407小平槽**

尺寸: Lx14.3x6.7mm
表面: 氧化铝本色/喷漆 (黑色/白色)
PC罩: 乳白/黑色/亚克力磨砂可选
适用: 12MM软灯带/硬灯条

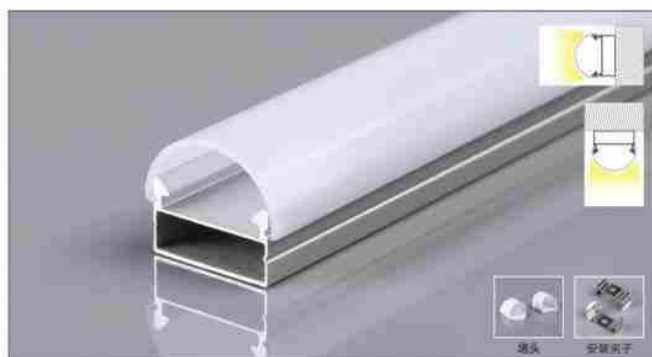

XT90

产品参数 **1509双层**

尺寸: Lx15x8.6mm
表面: 氧化铝本色/喷漆 (黑色/白色)
PC罩: 乳白
适用: 12MM软灯带/硬灯条

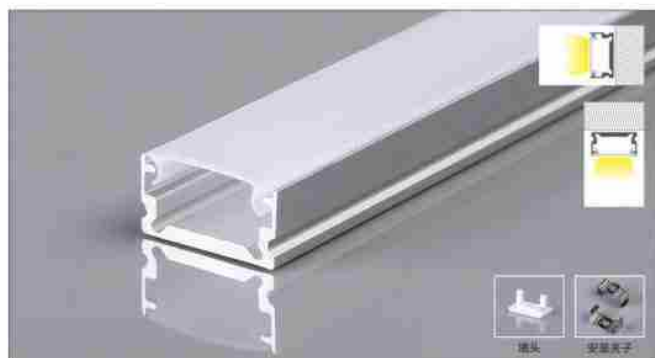
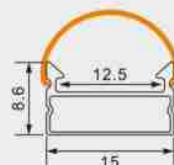

XT30

产品参数 **1307**

尺寸: Lx13.2x7mm
表面: 氧化铝本色/喷漆 (黑色/白色)
PC罩: 乳白/黑色/亚克力磨砂可选
适用: 10MM软灯带/硬灯条

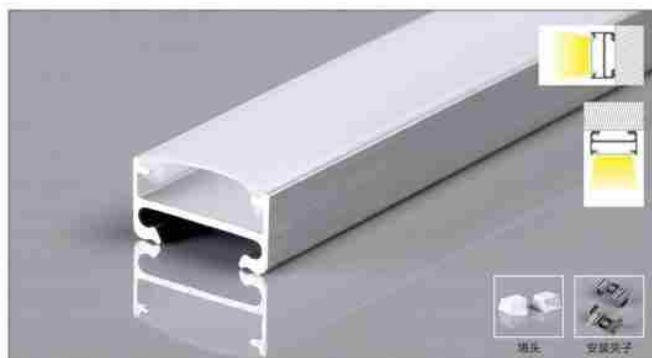

XT307

产品参数 **1307磁铁**

尺寸: Lx13.3x6.9mm
表面: 氧化铝本色/喷漆 (黑色/白色)
PC罩: 乳白/黑色/亚克力磨砂可选
适用: 12MM软灯带/硬灯条

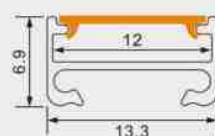

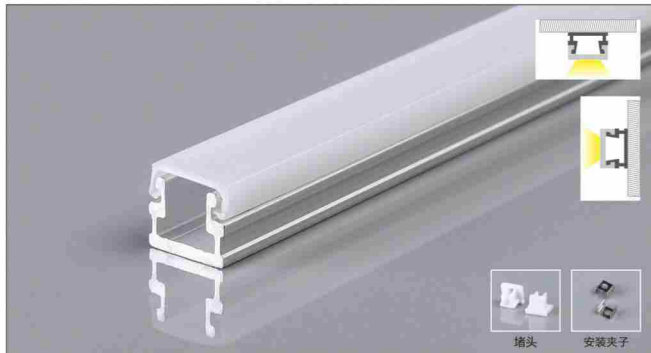

XT209

产品参数 **0808**

尺寸: Lx8x8mm
表面: 氧化铝本色/喷漆 (黑色/白色)
PC罩: 乳白/黑色/亚克力磨砂可选
适用: 5MM软灯带/硬灯条

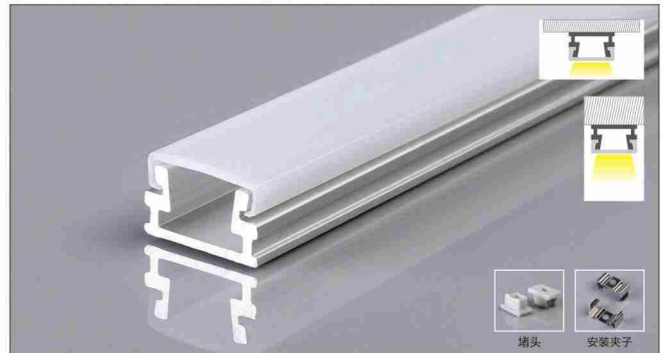
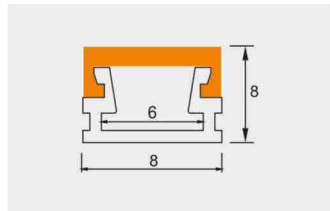

XT268

产品参数 **1208**

尺寸: Lx12x7.5mm
表面: 氧化铝本色/喷漆 (黑色/白色)
PC罩: 乳白/黑色/亚克力磨砂可选
适用: 8.5MM软灯带/硬灯条

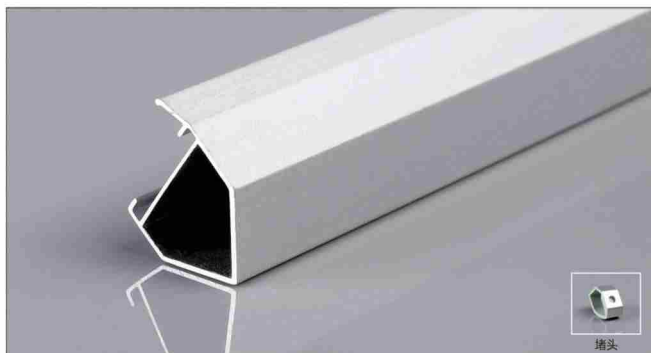
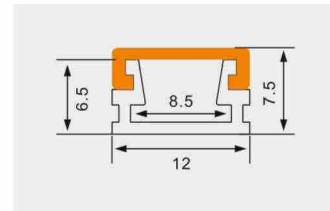

XT61

产品参数 **1915V型槽**

尺寸: Lx19x15mm
表面: 氧化铝本色/喷漆 (黑色/白色)
PC罩:
适用: 12MM硬灯条

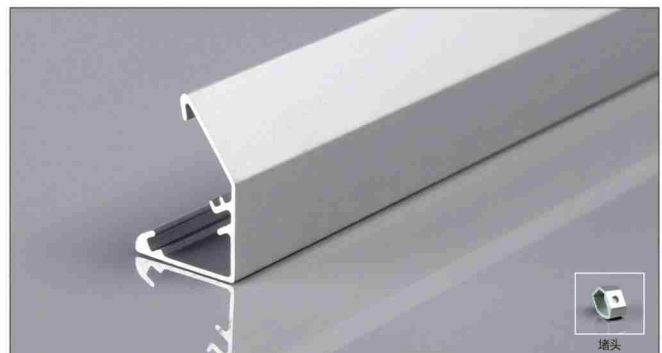
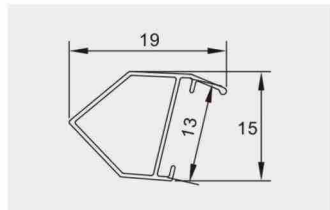

XT77

产品参数 **2114反光槽**

尺寸: Lx21x14mm
表面: 氧化铝本色/喷漆 (黑色/白色)
PC罩:
适用: 12MM硬灯条

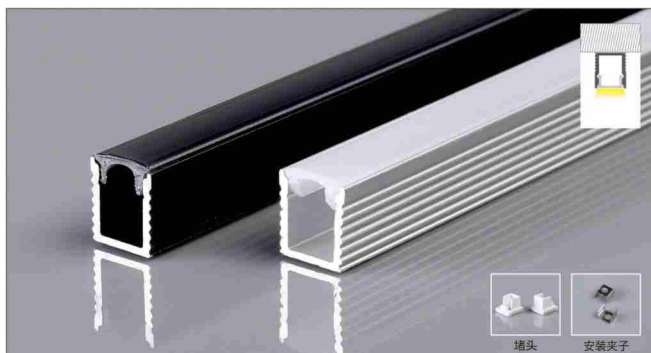
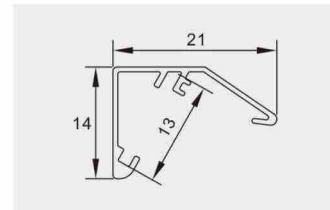

XT231

产品参数 **0809**

尺寸: Lx7.8x9mm
表面: 氧化铝本色/喷漆 (黑色/白色)
PC罩: 乳白/黑色/亚克力磨砂可选
适用: 5.5MM软灯带/硬灯条

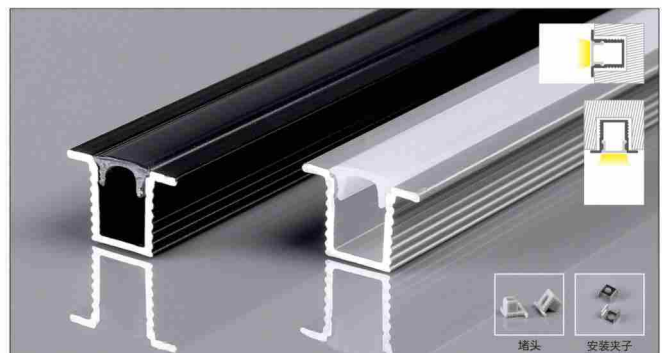
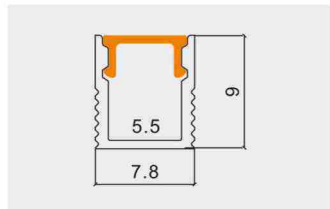

XT293

产品参数 **0809带边**

尺寸: Lx12.8x9mm
表面: 氧化铝本色/喷漆 (黑色/白色)
PC罩: 乳白/黑色/亚克力磨砂可选
适用: 5.5MM软灯带/硬灯条

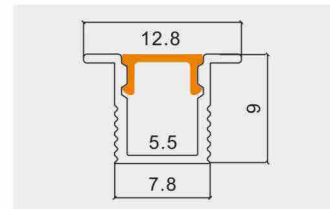

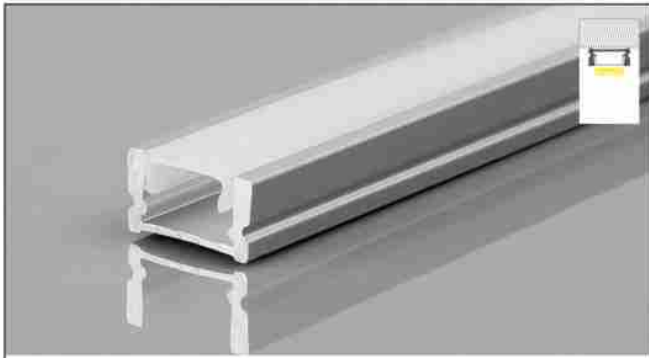

XT483

产品参数 **1107**

尺寸: Lx11x6.5mm
 表面: 氧化铝本色/喷漆 (黑色/白色)
 PC罩: 乳白/黑色/亚克力磨砂可选
 适用: 8MM软灯带/硬灯条

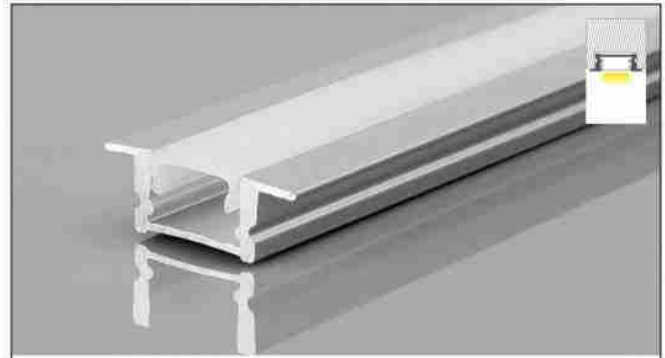
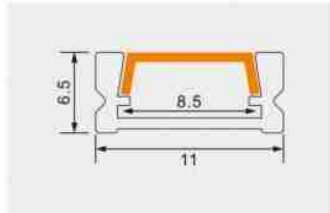

XT484

产品参数 **1107带边**

尺寸: Lx14x6.5mm
 表面: 氧化铝本色/喷漆 (黑色/白色)
 PC罩: 乳白/黑色/亚克力磨砂可选
 适用: 8MM软灯带/硬灯条

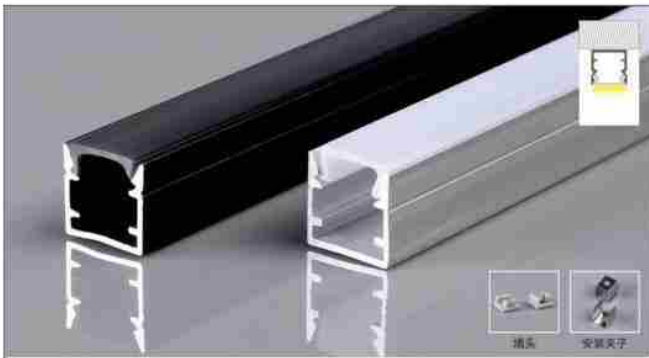
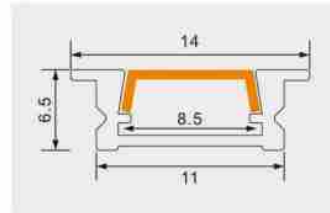

XT453

产品参数 **1010**

尺寸: Lx10x10mm
 表面: 氧化铝本色/喷漆 (黑色/白色)
 PC罩: 乳白/黑色/亚克力磨砂可选
 适用: 8MM软灯带/硬灯条

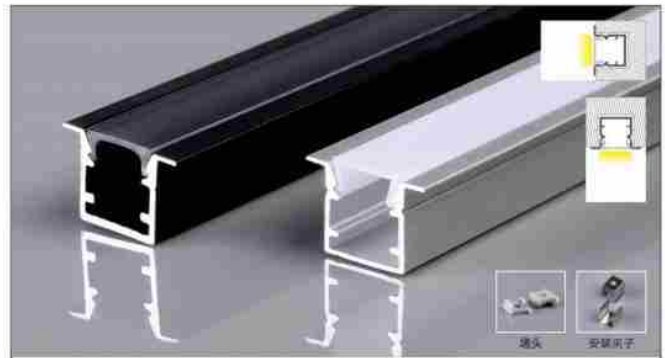
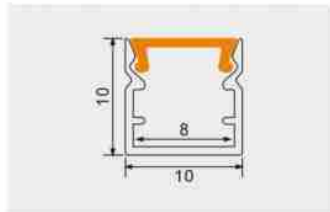

XT454

产品参数 **1010带边**

尺寸: Lx15x10mm
 表面: 氧化铝本色/喷漆 (黑色/白色)
 PC罩: 乳白/黑色/亚克力磨砂可选
 适用: 8MM软灯带/硬灯条

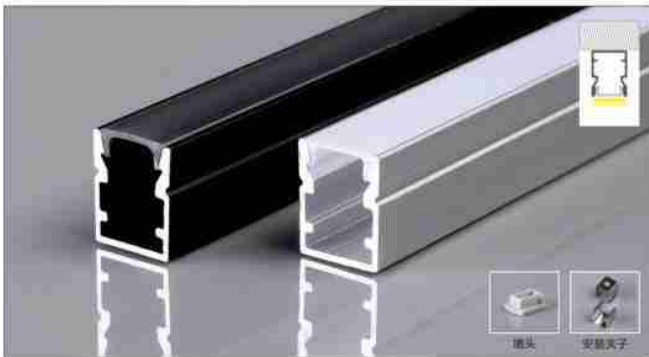
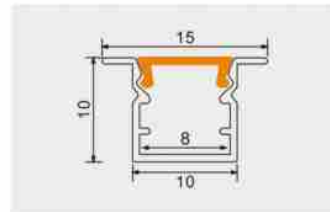

XT451

产品参数 **1013**

尺寸: Lx10x13mm
 表面: 氧化铝本色/喷漆 (黑色/白色)
 PC罩: 乳白/黑色/亚克力磨砂可选
 适用: 8MM软灯带/硬灯条

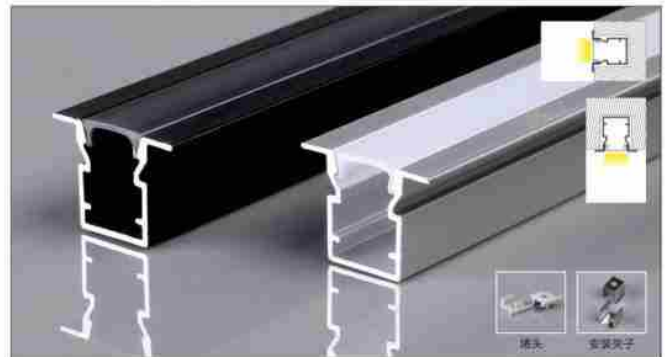
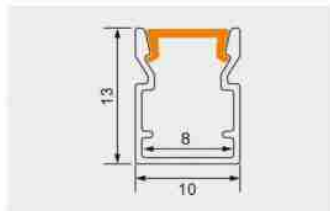

XT452

产品参数 **1013带边**

尺寸: Lx14x13mm
 表面: 氧化铝本色/喷漆 (黑色/白色)
 PC罩: 乳白/黑色/亚克力磨砂可选
 适用: 8MM软灯带/硬灯条

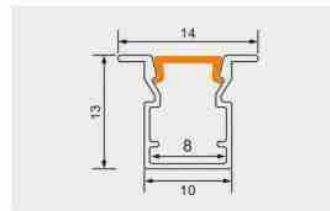

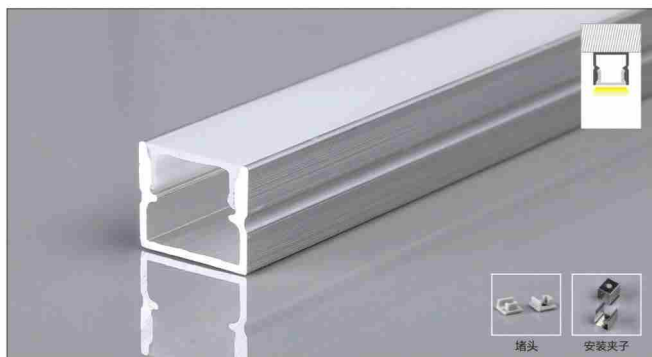

XT537

产品参数 **1210**

尺寸: Lx12x10mm
表面: 氧化铝本色/喷漆 (黑色/白色)
PC罩: 乳白/黑色/亚克力磨砂可选
适用: 10MM软灯带/硬灯条

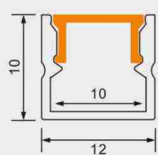

XT538

产品参数 **1210带边**

尺寸: Lx16x10mm
表面: 氧化铝本色/喷漆 (黑色/白色)
PC罩: 乳白/黑色/亚克力磨砂可选
适用: 10MM软灯带/硬灯条

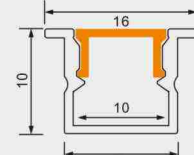

XT672

产品参数 **1212**

尺寸: Lx12x12mm
表面: 氧化铝本色/喷漆 (黑色/白色/玫瑰金)
PC罩: 乳白/黑色/亚克力磨砂可选
适用: 10MM软灯带

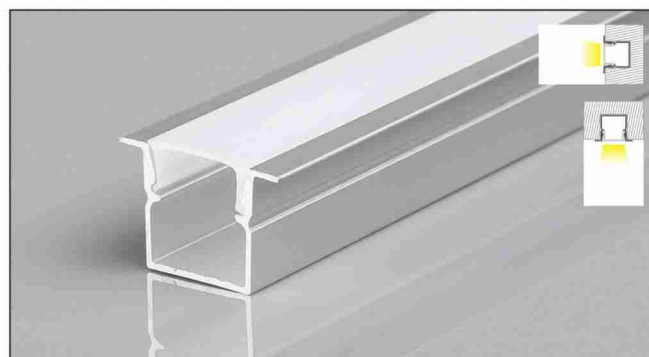
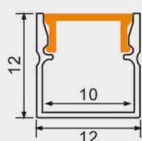

XT671

产品参数 **1212带边**

尺寸: Lx17.4x12mm
表面: 氧化铝本色/喷漆 (黑色/白色/玫瑰金)
PC罩: 乳白/黑色/亚克力磨砂可选
适用: 10MM软灯带

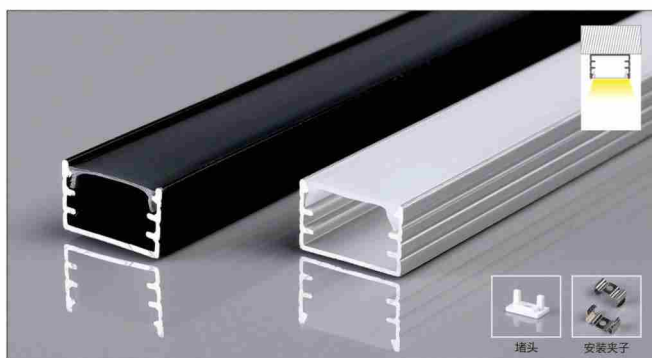
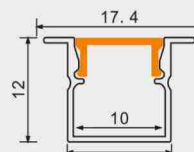

XT298

产品参数 **1509**

尺寸: Lx14.8x8.8mm
表面: 氧化铝本色/喷漆 (黑色/白色)
PC罩: 乳白/黑色/亚克力磨砂可选
适用: 12MM软灯带/硬灯条

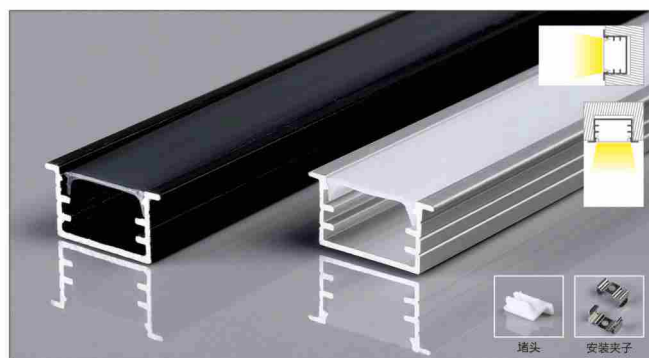
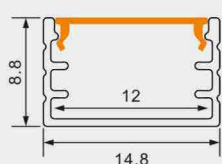

XT406

产品参数 **1509带边**

尺寸: Lx18.5x8.8mm
表面: 氧化铝本色/喷漆 (黑色/白色)
PC罩: 乳白/黑色/亚克力磨砂可选
适用: 12MM软灯带/硬灯条

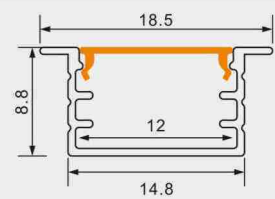

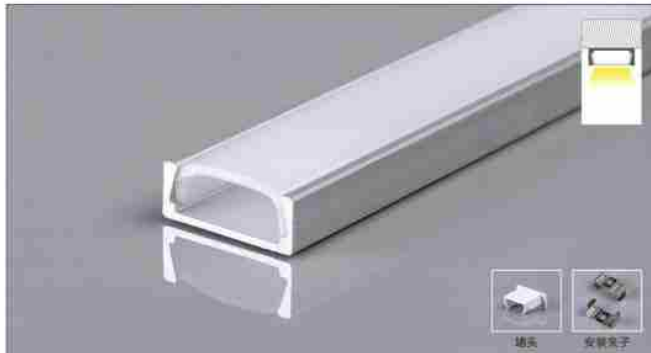

XT200

产品参数 **1606**

尺寸: Lx15.6x5.9mm
 表面: 氧化铝本色/喷漆 (黑色/白色)
 PC罩: 乳白/黑色/亚克力磨砂可选
 适用: 12MM软灯带/硬灯条

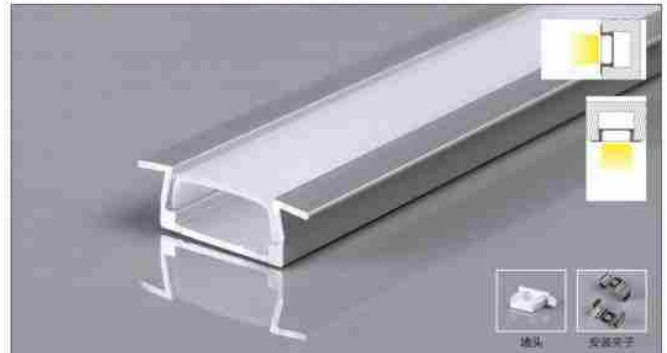
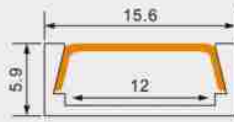

XT240

产品参数 **1607带边**

尺寸: Lx21.7x7mm
 表面: 氧化铝本色/喷漆 (黑色/白色)
 PC罩: 乳白/黑色/亚克力磨砂可选
 适用: 12MM软灯带/硬灯条

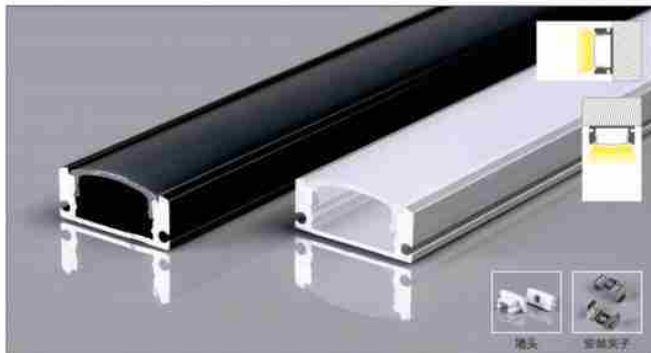
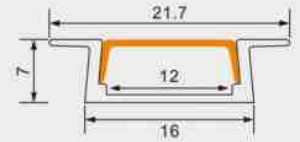

XT164

产品参数 **1707**

尺寸: Lx17.4x7mm
 表面: 氧化铝本色/喷漆 (黑色/白色)
 PC罩: 乳白/黑色/亚克力磨砂可选
 适用: 12MM软灯带/硬灯条

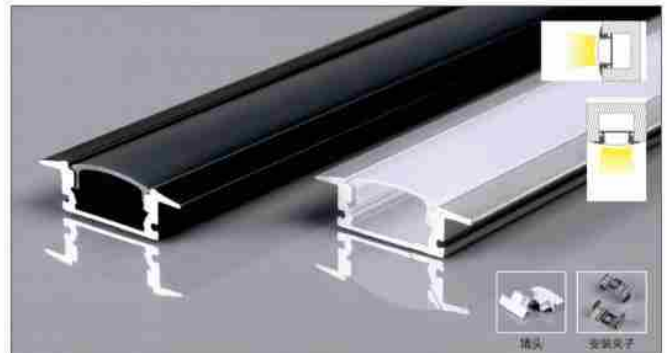
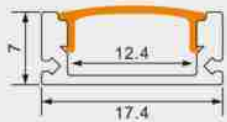

XT163

产品参数 **1707带边**

尺寸: Lx24.7x7mm
 表面: 氧化铝本色/喷漆 (黑色/白色)
 PC罩: 乳白/黑色/亚克力磨砂可选
 适用: 12MM软灯带/硬灯条

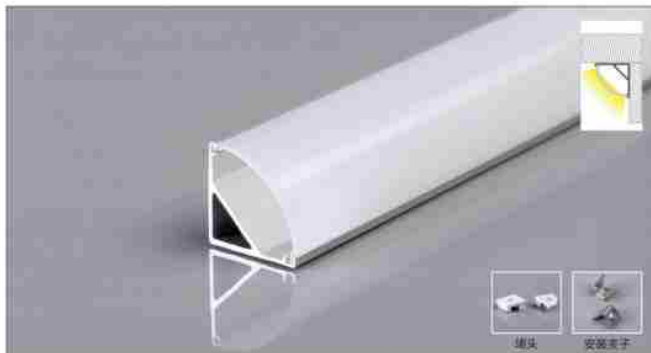
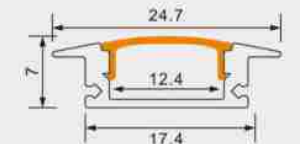

XT407

产品参数 **1313三角**

尺寸: Lx13x13mm
 表面: 氧化铝本色/喷漆 (黑色/白色)
 PC罩: 乳白/黑色/亚克力磨砂可选
 适用: 8MM软灯带/硬灯条

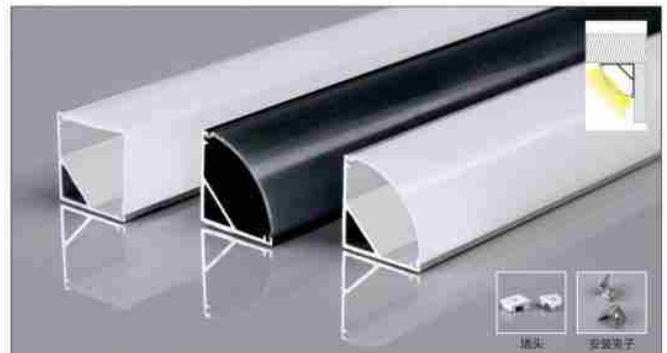
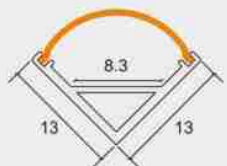

XT58

产品参数 **1616三角**

尺寸: Lx15.8x15.8mm
 表面: 氧化铝本色/喷漆 (黑色/白色)
 PC罩: 乳白/黑色/亚克力磨砂可选
 适用: 10MM软灯带/硬灯条

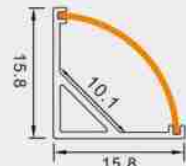

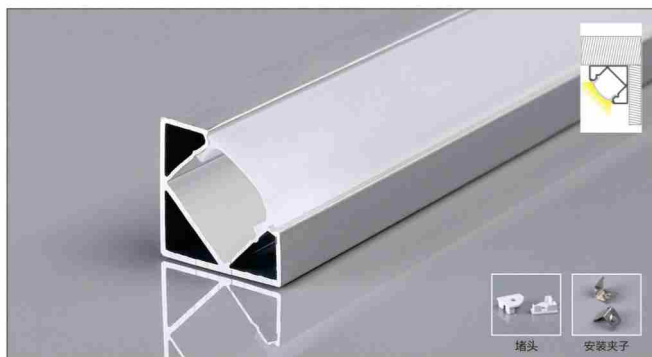

XT59

产品参数 **1919三角**

尺寸: Lx19x19mm
表面: 氧化铝本色/喷漆 (黑色/白色)
PC罩: 乳白/黑色/亚克力磨砂可选
适用: 12MM软灯带/硬灯条

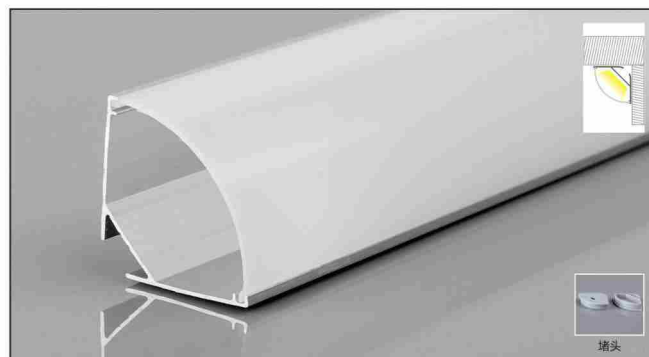
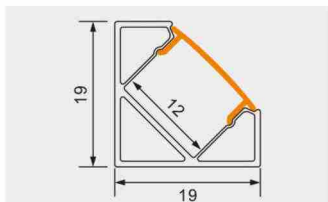

XT632

产品参数 **2020三角**

尺寸: Lx20x20mm
表面: 氧化铝本色/喷漆 (黑色/白色)
PC罩: 乳白/黑色/亚克力磨砂可选
适用: 12MM软灯带/硬灯条

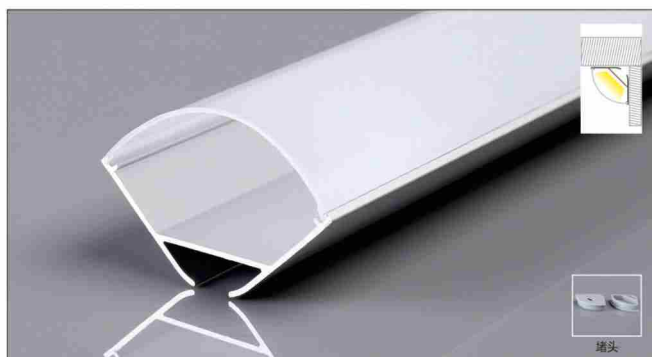
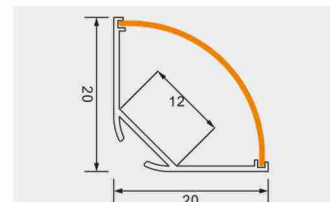

XT199

产品参数 **3030三角**

尺寸: Lx41.3x25mm
表面: 氧化铝本色/喷漆 (黑色/白色)
PC罩: 乳白/黑色/亚克力磨砂可选
适用: 20MM软灯带/硬灯条

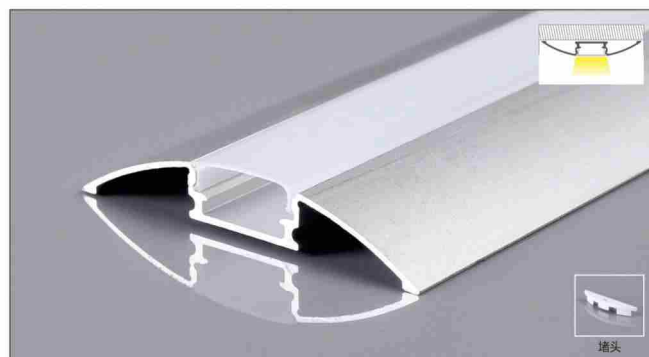
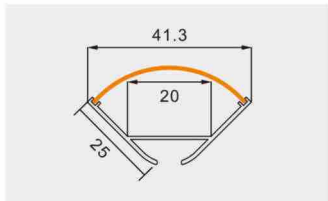

XT67

产品参数 **5409弧形**

尺寸: Lx54x8.8mm
表面: 氧化铝本色/喷漆 (黑色/白色)
PC罩: 乳白/黑色/亚克力磨砂可选
适用: 12MM软灯带/硬灯条

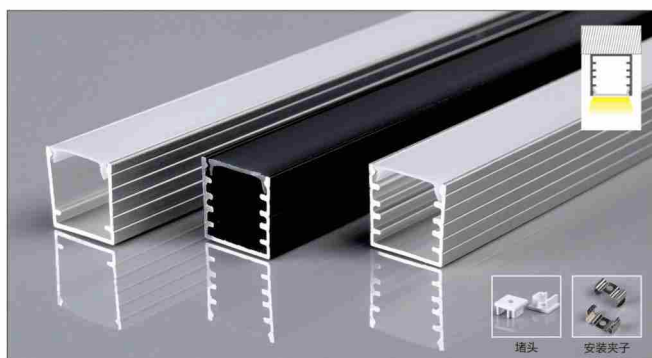
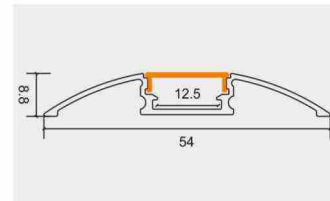

XT444

产品参数 **1515**

尺寸: Lx14.5x14.5mm
表面: 氧化铝本色/喷漆 (黑色/白色)
PC罩: 乳白/黑色/亚克力磨砂可选
适用: 12MM软灯带/硬灯条

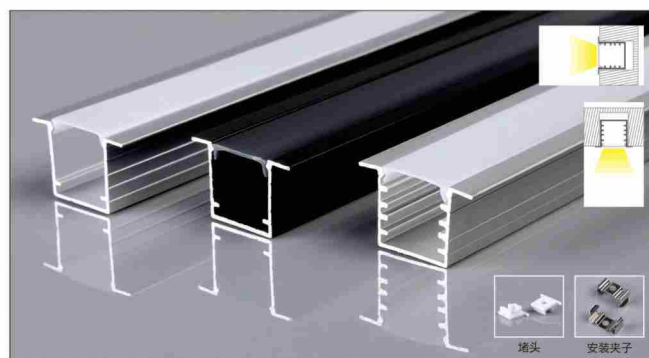
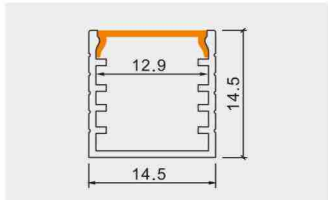

XT445

产品参数 **1515带边**

尺寸: Lx23x14.5mm
表面: 氧化铝本色/喷漆 (黑色/白色)
PC罩: 乳白/黑色/亚克力磨砂可选
适用: 12MM软灯带/硬灯条

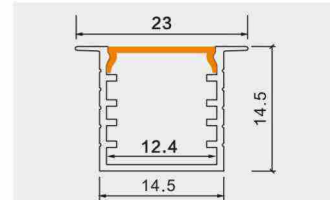

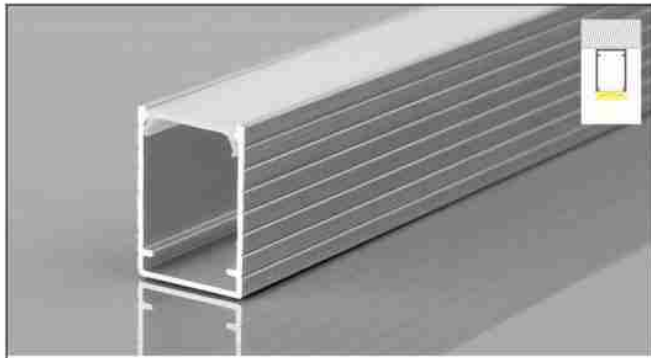

XT580

产品参数 **1420**

尺寸: Lx14x20mm
 表面: 氧化铝本色/喷漆 (黑色/白色)
 PC罩: 乳白/黑色/亚克力磨砂可选
 适用: 12MM软灯带/硬灯条

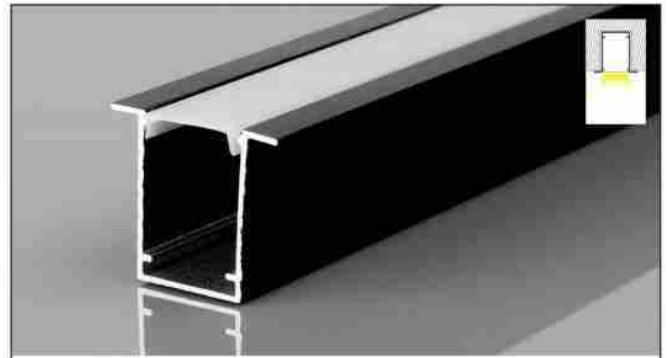
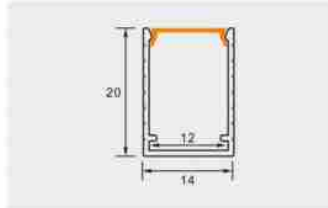

XT581

产品参数 **1420带边**

尺寸: Lx22x14mm
 表面: 氧化铝本色/喷漆 (黑色/白色)
 PC罩: 乳白/黑色/亚克力磨砂可选
 适用: 12MM软灯带/硬灯条

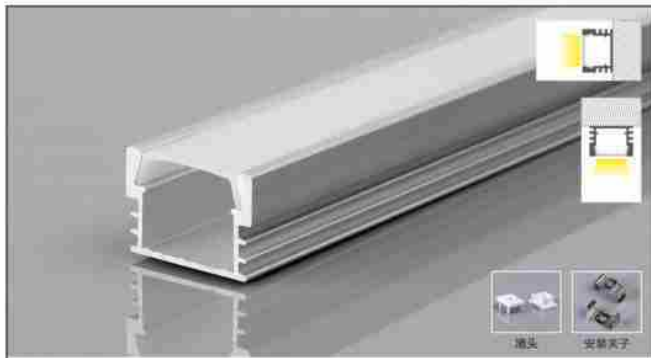

XT211

产品参数 **1712**

尺寸: Lx17.5x12.2mm
 表面: 氧化铝本色/喷漆 (黑色/白色)
 PC罩: 乳白/黑色/亚克力磨砂可选
 适用: 12MM软灯带/硬灯条

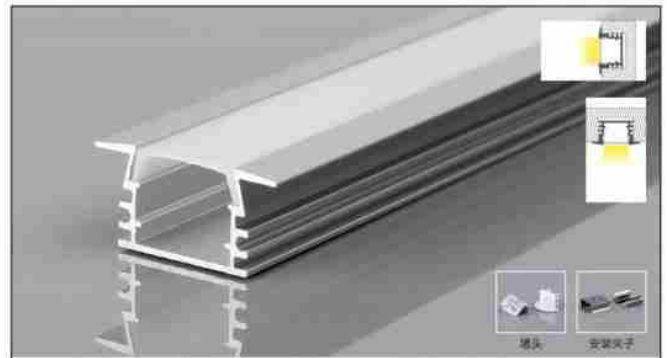
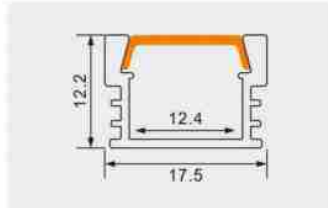

XT217

产品参数 **1712带边**

尺寸: Lx24.5x12.2mm
 表面: 氧化铝本色/喷漆 (黑色/白色)
 PC罩: 乳白/黑色/亚克力磨砂可选
 适用: 12MM软灯带/硬灯条

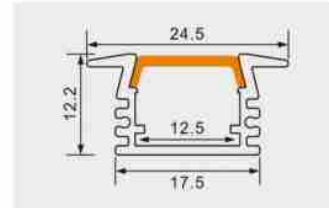

XT397

产品参数 **1712**

尺寸: Lx17.5x12.2mm
 表面: 氧化铝本色/喷漆 (黑色/白色)
 PC罩: 乳白/黑色/亚克力磨砂可选
 适用: 12MM软灯带/硬灯条

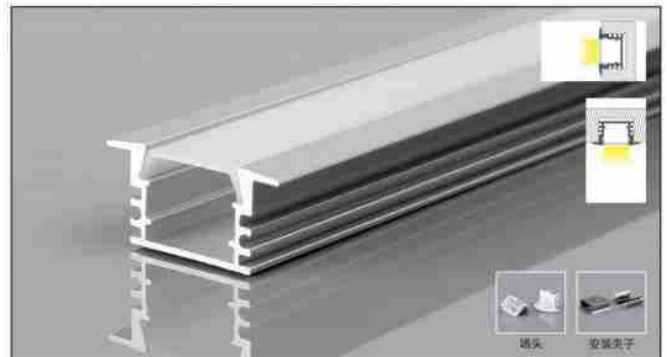
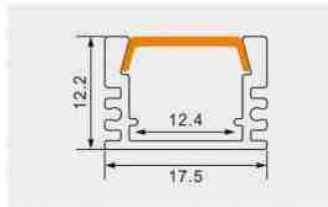

XT255

产品参数 **1712带边**

尺寸: Lx24.5x12.2mm
 表面: 氧化铝本色/喷漆 (黑色/白色)
 PC罩: 乳白/黑色/亚克力磨砂可选
 适用: 12MM软灯带/硬灯条

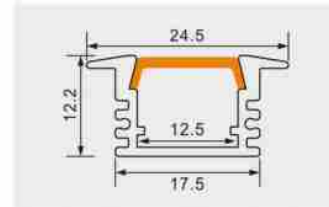

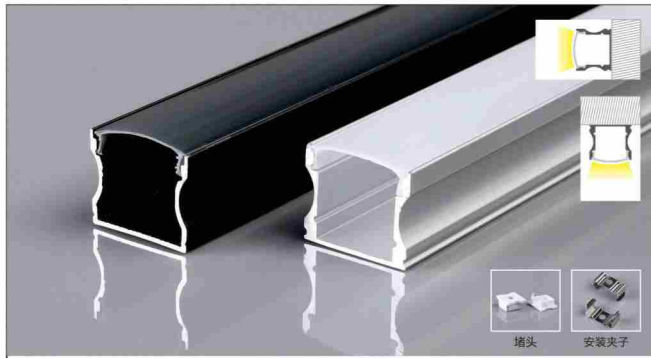

XT393

产品参数 **1715**

尺寸: Lx17.2x14.5mm
表面: 氧化铝本色/喷漆 (黑色/白色)
PC罩: 乳白/黑色/亚克力磨砂可选
适用: 12MM软灯带/硬灯条

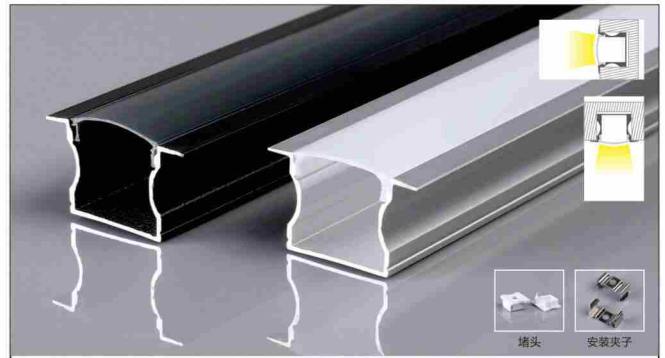
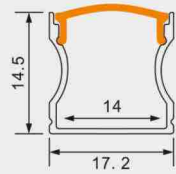

XT394

产品参数 **1715带边**

尺寸: Lx24x14.5mm
表面: 氧化铝本色/喷漆 (黑色/白色)
PC罩: 乳白/黑色/亚克力磨砂可选
适用: 12MM软灯带/硬灯条

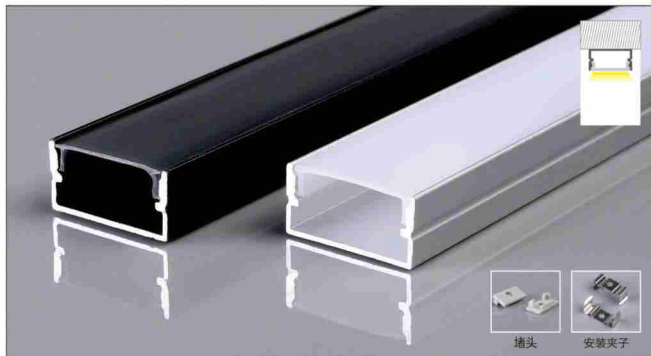
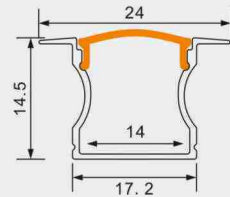

XT385

产品参数 **2010**

尺寸: Lx20x10mm
表面: 氧化铝本色/喷漆 (黑色/白色)
PC罩: 乳白/黑色/亚克力磨砂可选
适用: 17MM软灯带/硬灯条

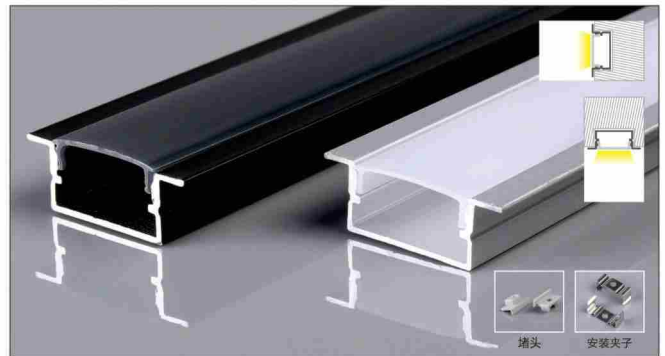
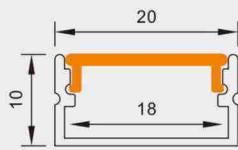

XT400

产品参数 **2010带边**

尺寸: Lx28x10mm
表面: 氧化铝本色/喷漆 (黑色/白色)
PC罩: 乳白/黑色/亚克力磨砂可选
适用: 17MM软灯带/硬灯条

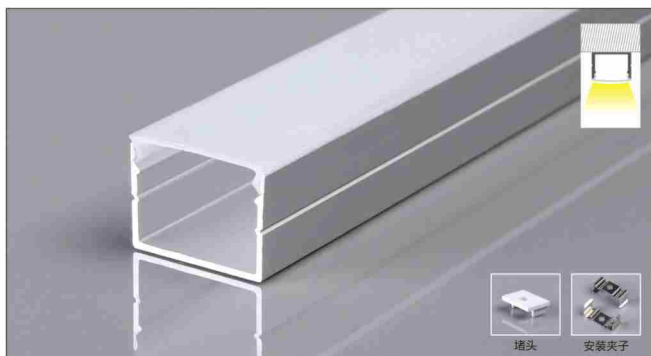
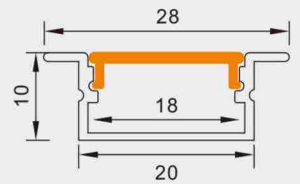

XT340

产品参数 **1813**

尺寸: Lx18.3x13mm
表面: 氧化铝本色/喷漆 (黑色/白色)
PC罩: 乳白/黑色/亚克力磨砂可选
适用: 15MM软灯带/硬灯条

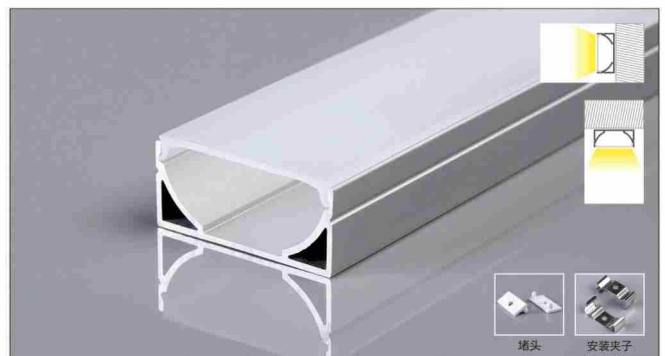
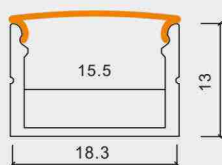

XT194

产品参数 **2712**

尺寸: Lx27x11.8mm
表面: 氧化铝本色/喷漆 (黑色/白色)
PC罩: 乳白/黑色/亚克力磨砂可选
适用: 12MM软灯带/硬灯条

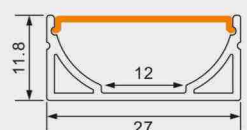

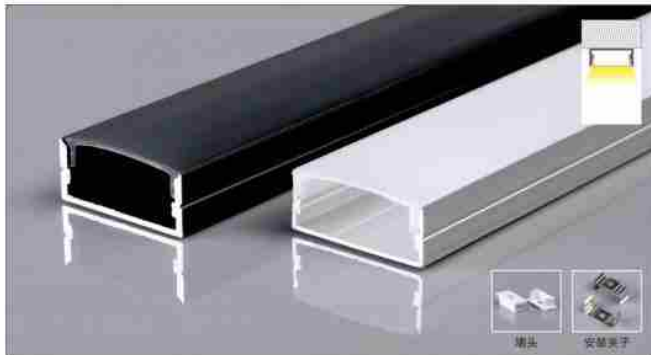

XT438

产品参数 **2310**

尺寸: Lx23.5x9.8mm
 表面: 氧化铝本色/喷漆 (黑色/白色)
 PC罩: 乳白/黑色/亚克力磨砂可选
 适用: 20MM软灯带/硬灯条

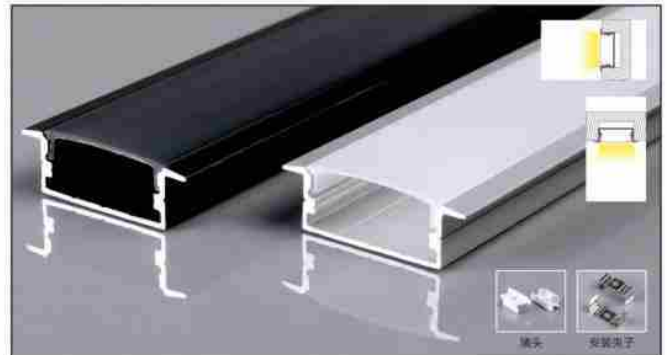
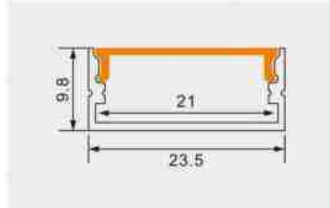

XT439

产品参数 **2310带边**

尺寸: Lx29x9.8mm
 表面: 氧化铝本色/喷漆 (黑色/白色)
 PC罩: 乳白/黑色/亚克力磨砂可选
 适用: 20MM软灯带/硬灯条

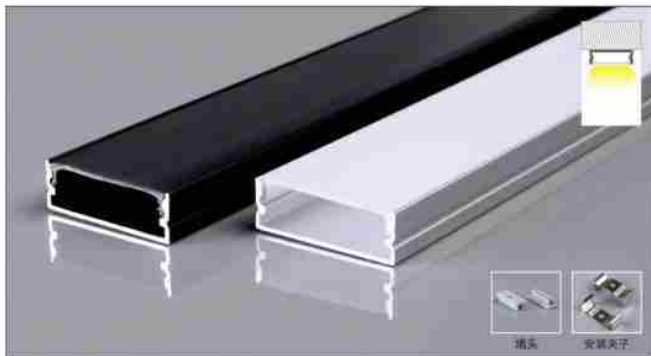
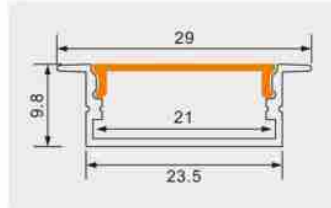

XT446

产品参数 **3010**

尺寸: Lx30x10mm
 表面: 氧化铝本色/喷漆 (黑色/白色)
 PC罩: 乳白/黑色/亚克力磨砂可选
 适用: 27MM软灯带/硬灯条

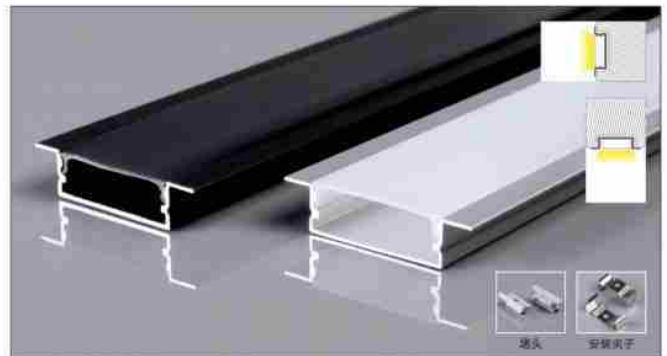
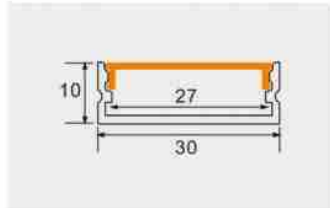

XT447

产品参数 **3010带边**

尺寸: Lx41x10mm
 表面: 氧化铝本色/喷漆 (黑色/白色)
 PC罩: 乳白/黑色/亚克力磨砂可选
 适用: 27MM软灯带/硬灯条

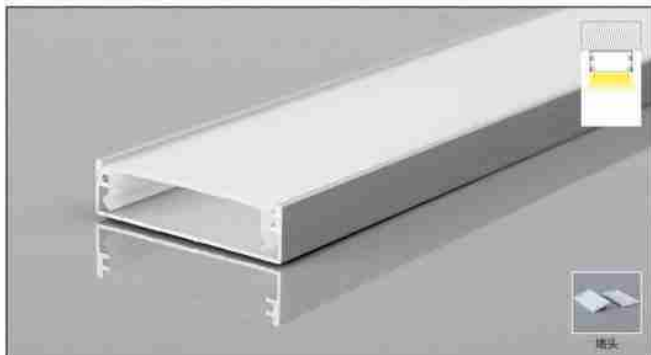
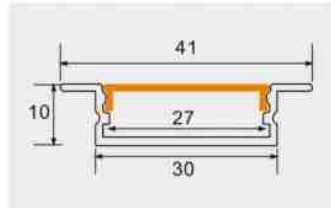

XT795

产品参数 **4010**

尺寸: Lx40x10mm
 表面: 氧化铝本色/喷漆 (黑色/白色)
 PC罩: 乳白/黑色/亚克力磨砂可选
 适用: 37MM软灯带/硬灯条

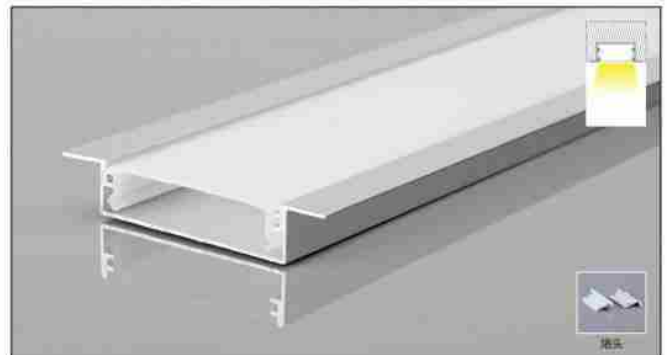
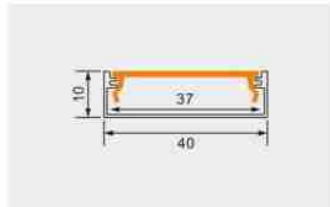

XT796

产品参数 **4010带边**

尺寸: Lx55x10mm
 表面: 氧化铝本色/喷漆 (黑色/白色)
 PC罩: 乳白/黑色/亚克力磨砂可选
 适用: 37MM软灯带/硬灯条

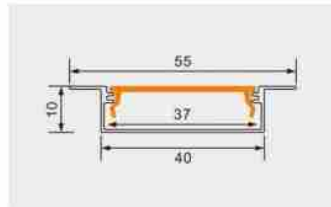

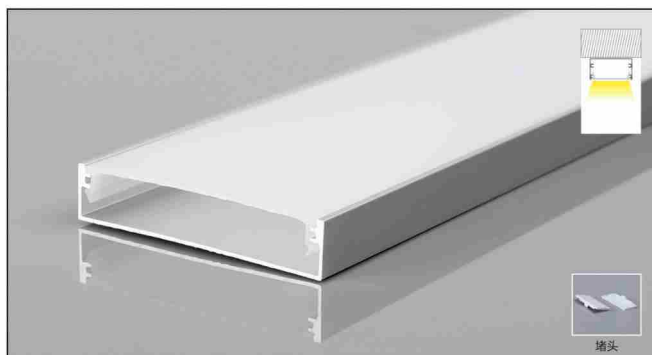

XT797

产品参数 **5010**

尺寸: Lx50x10mm
表面: 氧化铝本色/喷漆 (黑色/白色)
PC罩: 乳白/黑色/亚克力磨砂可选
适用: 47MM软灯带/硬灯条

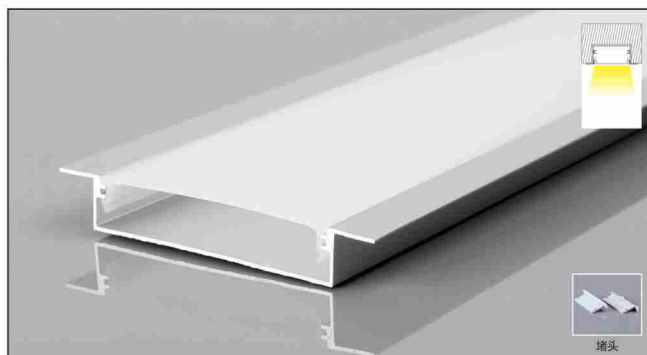
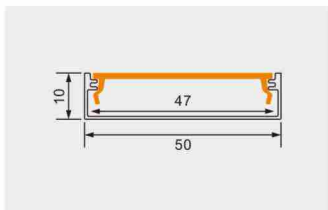

XT798

产品参数 **5010带边**

尺寸: Lx65x10mm
表面: 氧化铝本色/喷漆 (黑色/白色)
PC罩: 乳白/黑色/亚克力磨砂可选
适用: 47MM软灯带/硬灯条

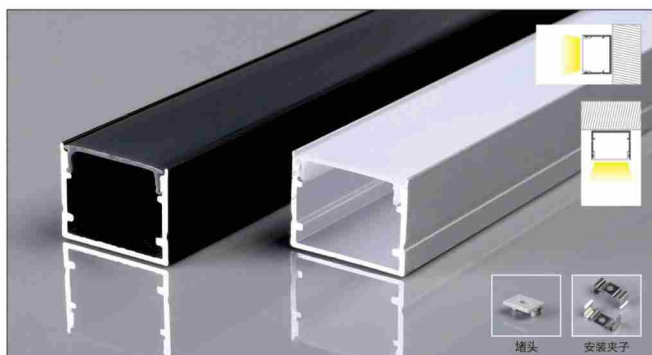
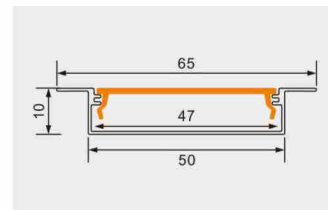

XT398

产品参数 **2015**

尺寸: Lx20x15mm
表面: 氧化铝本色/喷漆 (黑色/白色)
PC罩: 乳白/黑色/亚克力磨砂可选
适用: 17MM软灯带/硬灯条

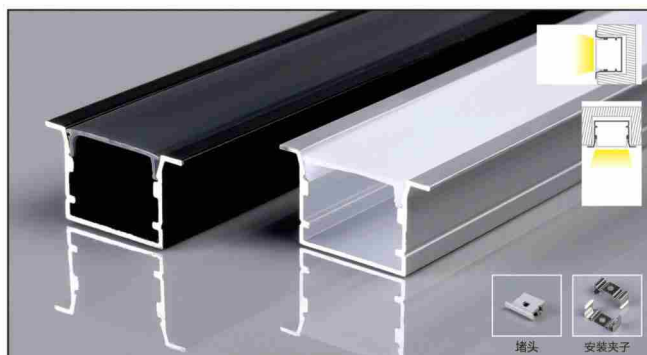
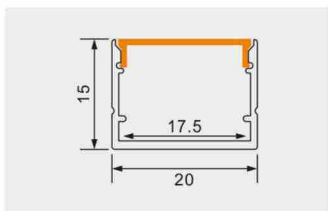

XT433

产品参数 **2015带边**

尺寸: Lx27x15mm
表面: 氧化铝本色/喷漆 (黑色/白色)
PC罩: 乳白/黑色/亚克力磨砂可选
适用: 17MM软灯带/硬灯条

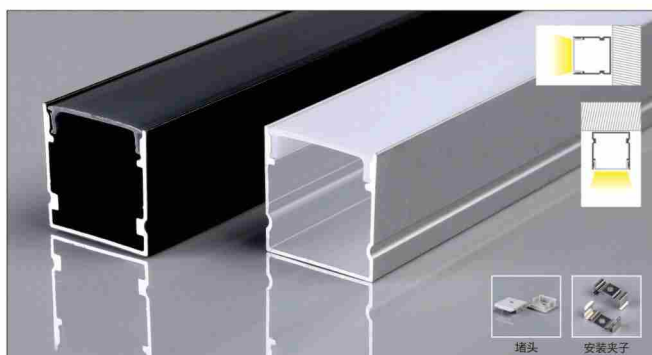
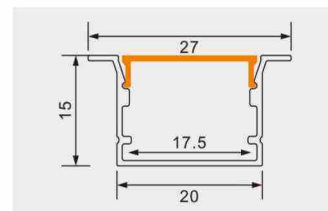

XT432

产品参数 **2020**

尺寸: Lx20x20mm
表面: 氧化铝本色/喷漆 (黑色/白色)
PC罩: 乳白/黑色/亚克力磨砂可选
适用: 17MM软灯带/硬灯条

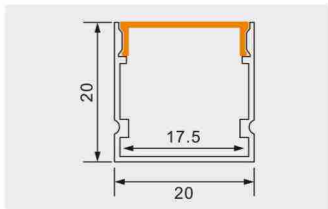

XT431

产品参数 **2020带边**

尺寸: Lx27x20mm
表面: 氧化铝本色/喷漆 (黑色/白色)
PC罩: 乳白/黑色/亚克力磨砂可选
适用: 17MM软灯带/硬灯条

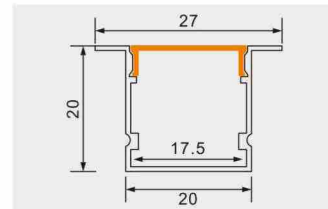

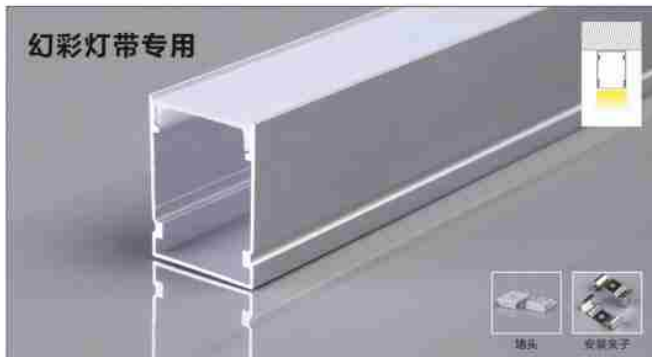

XT457

产品参数 **2025**

尺寸: Lx20x25mm
 表面: 氧化铝本色/喷漆 (黑色/白色)
 PC罩: 乳白/黑色/亚克力磨砂可选
 适用: 17MM软灯带/硬灯条

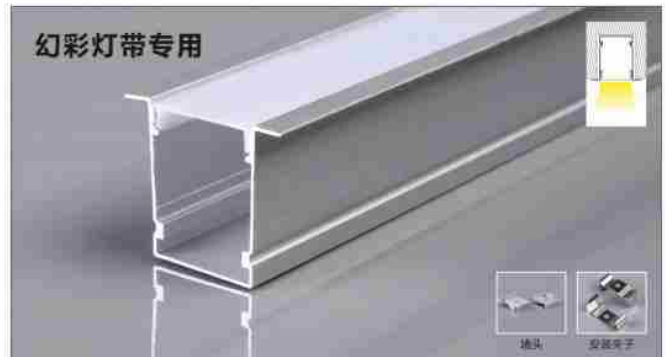
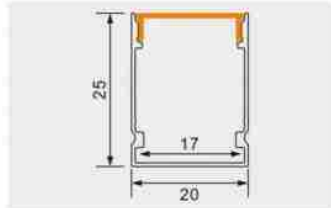

XT458

产品参数 **2025带边**

尺寸: Lx28x25mm
 表面: 氧化铝本色/喷漆 (黑色/白色)
 PC罩: 乳白/黑色/亚克力磨砂可选
 适用: 17MM软灯带/硬灯条

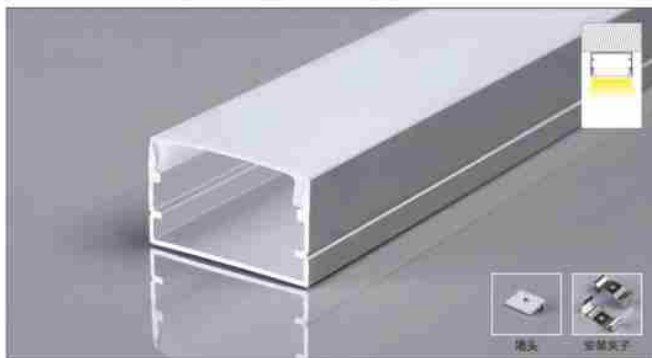
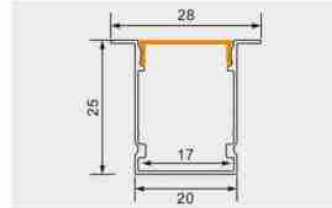

XT434

产品参数 **2515**

尺寸: Lx25x15mm
 表面: 氧化铝本色/喷漆 (黑色/白色)
 PC罩: 乳白/黑色/亚克力磨砂可选
 适用: 22MM软灯带/硬灯条

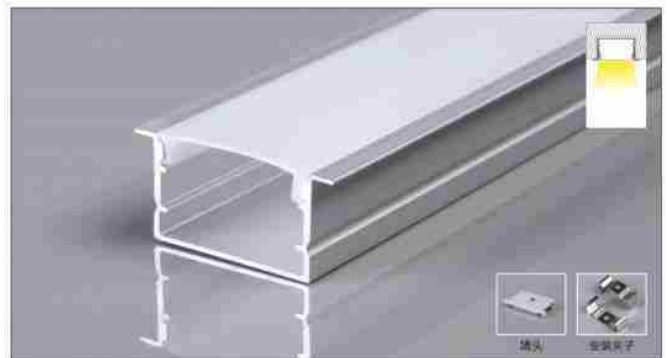
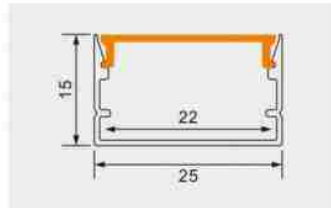

XT414

产品参数 **2515带边**

尺寸: Lx31x15mm
 表面: 氧化铝本色/喷漆 (黑色/白色)
 PC罩: 乳白/黑色/亚克力磨砂可选
 适用: 22MM软灯带/硬灯条

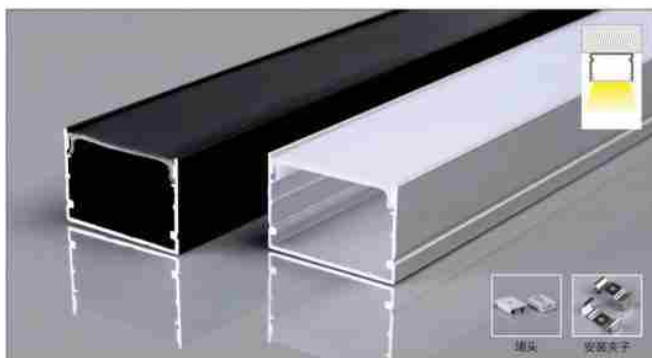
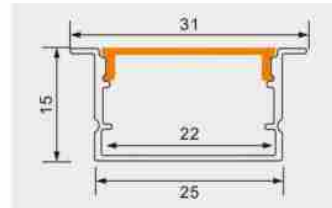

XT455

产品参数 **3020**

尺寸: Lx30x20mm
 表面: 氧化铝本色/喷漆 (黑色/白色)
 PC罩: 乳白/黑色/亚克力磨砂可选
 适用: 27MM软灯带/硬灯条

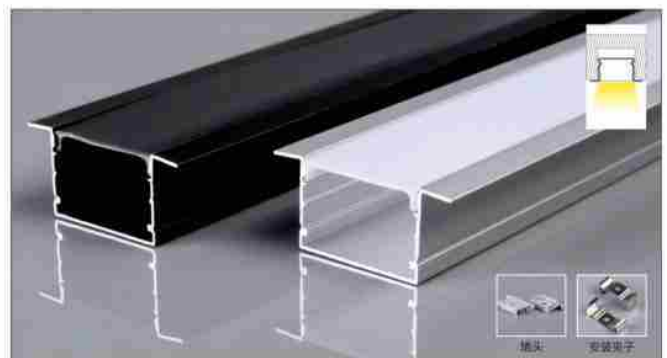
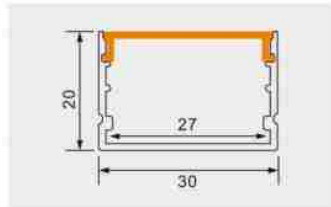

XT456

产品参数 **3020带边**

尺寸: Lx43x20mm
 表面: 氧化铝本色/喷漆 (黑色/白色)
 PC罩: 乳白/黑色/亚克力磨砂可选
 适用: 27MM软灯带/硬灯条

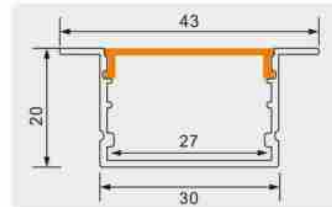

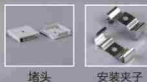
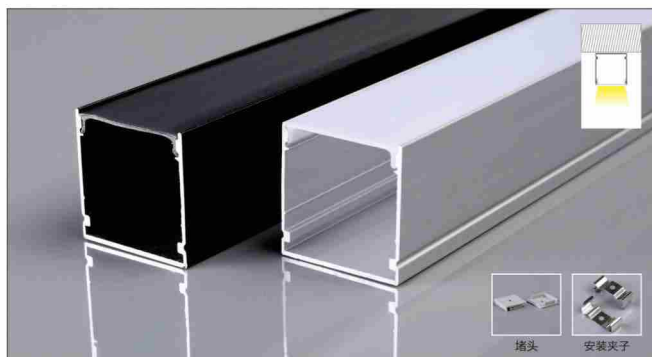

XT371

产品参数 **3030**

尺寸: Lx30x30mm
表面: 氧化铝本色/喷漆 (黑色/白色)
PC罩: 乳白/黑色/亚克力磨砂可选
适用: 27MM软灯带/硬灯条

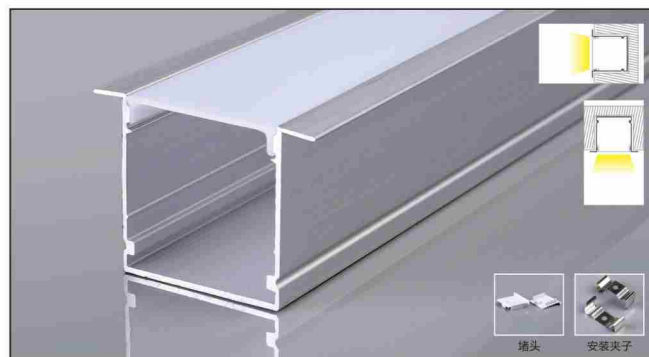
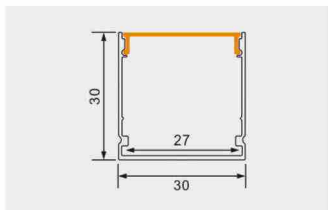

XT551

产品参数 **3030带边**

尺寸: Lx42x30mm
表面: 氧化铝本色/喷漆 (黑色/白色)
PC罩: 乳白/黑色/亚克力磨砂可选
适用: 27MM软灯带/硬灯条

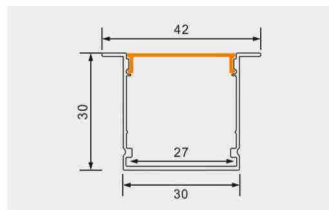

XT341

产品参数 **2320**

尺寸: Lx23x20mm
表面: 氧化铝本色/喷漆 (黑色/白色)
PC罩: 乳白/黑色/亚克力磨砂可选
适用: 20MM软灯带/硬灯条

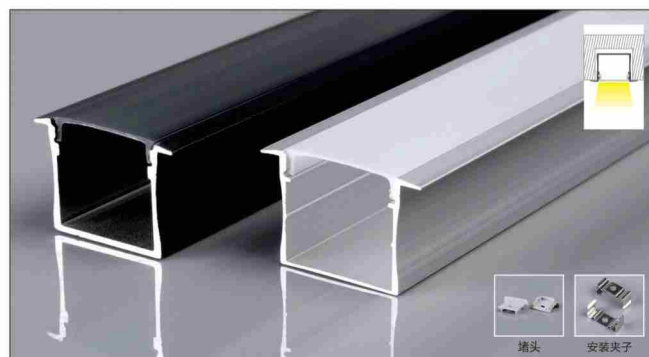
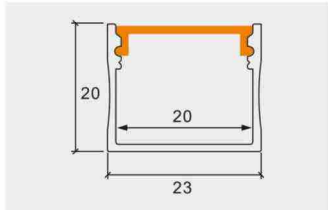

XT335

产品参数 **2320带边**

尺寸: Lx30x20mm
表面: 氧化铝本色/喷漆 (黑色/白色)
PC罩: 乳白/黑色/亚克力磨砂可选
适用: 20MM软灯带/硬灯条

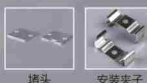
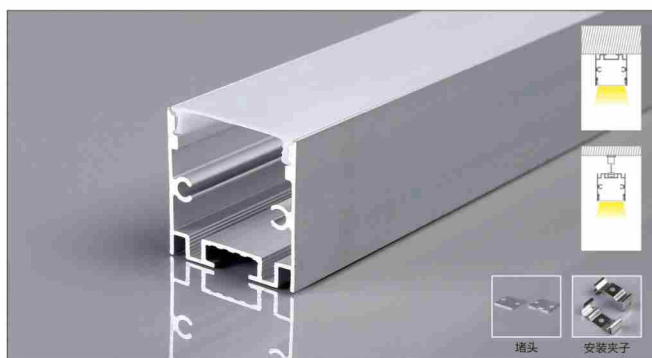
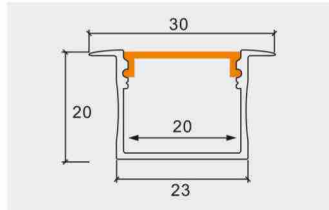

XT372

产品参数 **2525**

尺寸: Lx25x25mm
表面: 氧化铝本色/喷漆 (黑色/白色)
PC罩: 乳白/黑色/亚克力磨砂可选
适用: 22MM软灯带/硬灯条

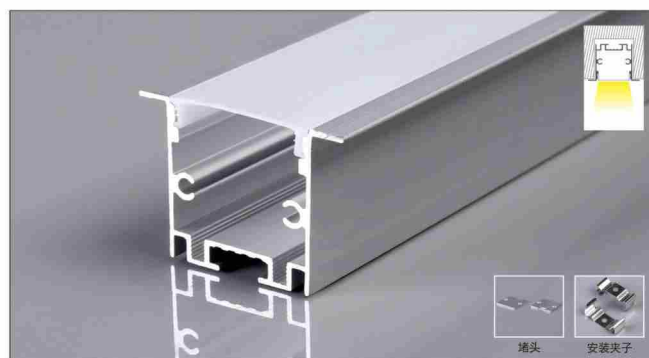
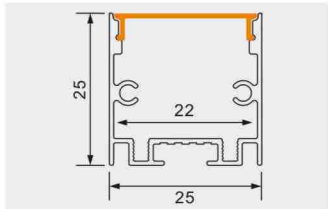

XT332

产品参数 **2525带边**

尺寸: Lx35x25mm
表面: 氧化铝本色/喷漆 (黑色/白色)
PC罩: 乳白/黑色/亚克力磨砂可选
适用: 22MM软灯带/硬灯条

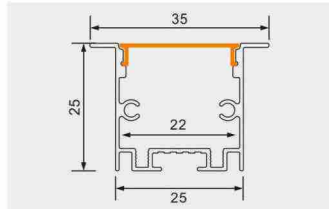

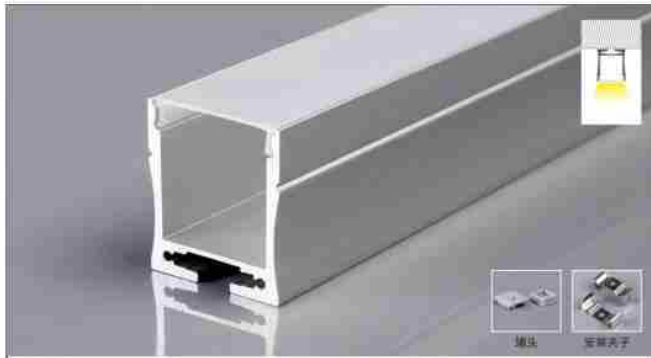

XT339

产品参数 **2327**

尺寸: Lx23x27mm
 表面: 氧化铝本色/喷漆 (黑色/白色)
 PC罩: 乳白/黑色/亚克力磨砂可选
 适用: 18MM软灯带/硬灯条

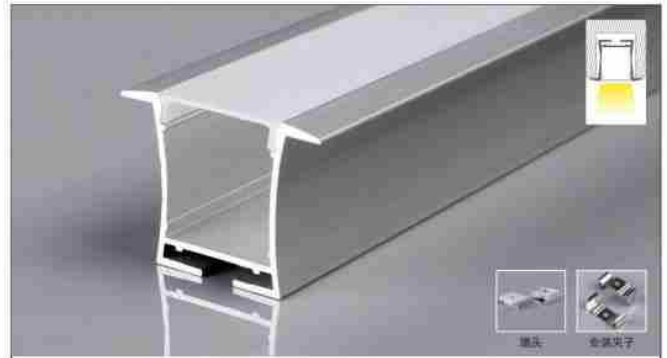
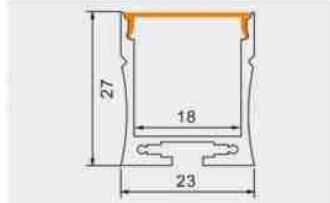

XT338

产品参数 **2327带边**

尺寸: Lx36x27,6mm
 表面: 氧化铝本色/喷漆 (黑色/白色)
 PC罩: 乳白/黑色/亚克力磨砂可选
 适用: 18MM软灯带/硬灯条

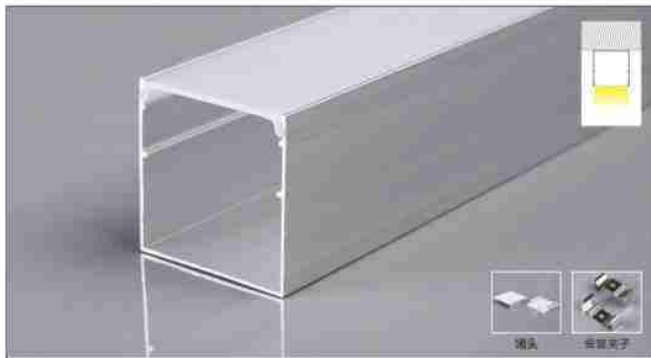
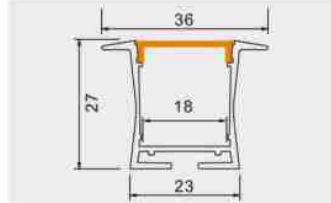

XT440

产品参数 **3535**

尺寸: Lx35x35mm
 表面: 氧化铝本色/喷漆 (黑色/白色)
 PC罩: 乳白/黑色/亚克力磨砂可选
 适用: 32MM软灯带/硬灯条

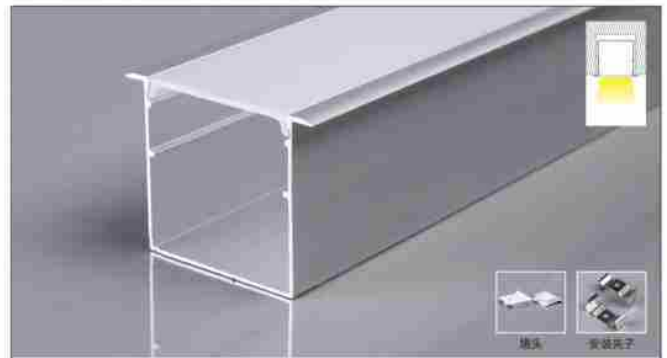
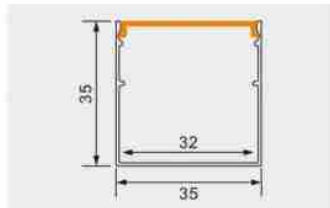

XT441

产品参数 **3535带边**

尺寸: Lx43x35mm
 表面: 氧化铝本色/喷漆 (黑色/白色)
 PC罩: 乳白/黑色/亚克力磨砂可选
 适用: 32MM软灯带/硬灯条

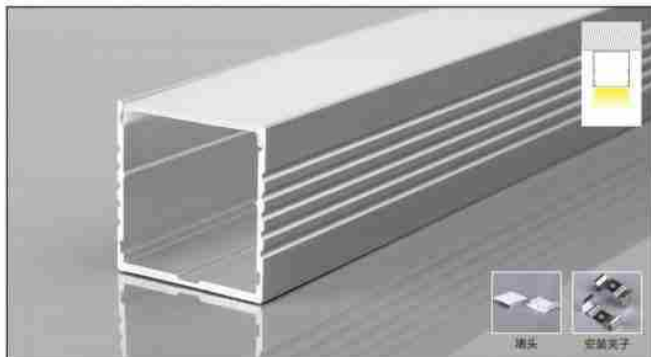
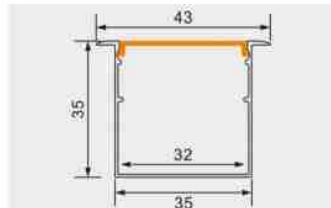

XT205

产品参数 **3535**

尺寸: Lx35x35mm
 表面: 氧化铝本色/喷漆 (黑色/白色)
 PC罩: 乳白/黑色/亚克力磨砂可选
 适用: 32MM软灯带/硬灯条

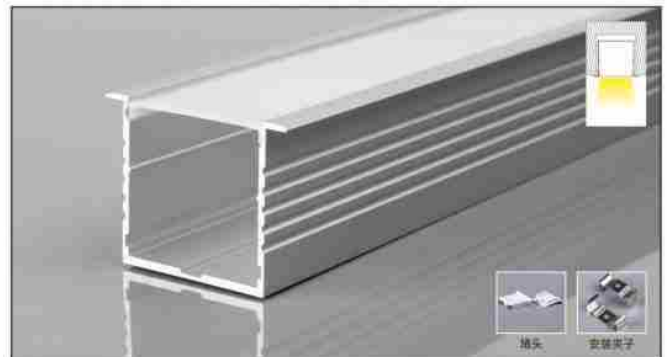
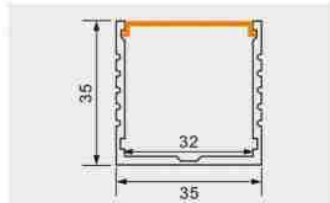

XT204

产品参数 **3535带边**

尺寸: Lx43x35mm
 表面: 氧化铝本色/喷漆 (黑色/白色)
 PC罩: 乳白/黑色/亚克力磨砂可选
 适用: 32MM软灯带/硬灯条

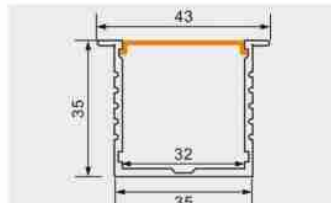

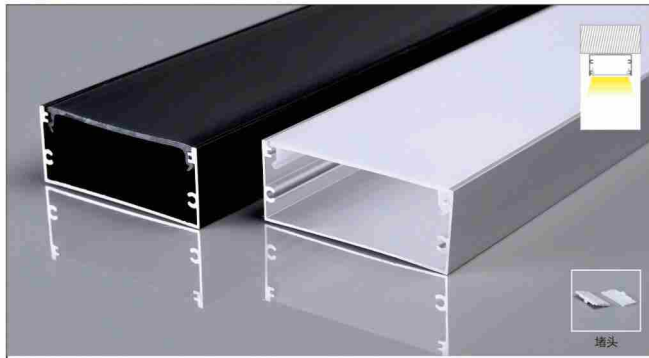

XT442

产品参数 **5020**

尺寸: Lx50x20mm
表面: 氧化铝本色/喷漆 (黑色/白色)
PC罩: 乳白/黑色/亚克力磨砂可选
适用: 47MM软灯带/硬灯条

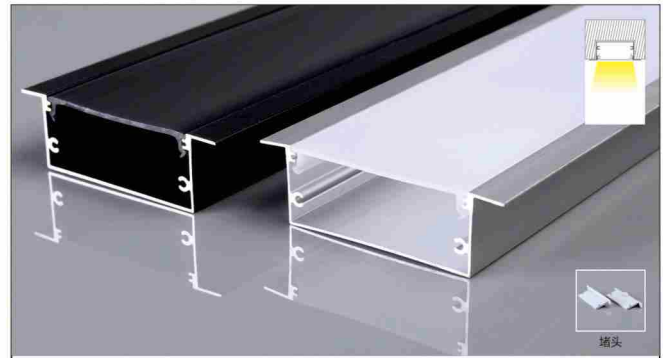
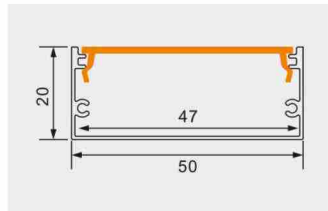

XT443

产品参数 **5020带边**

尺寸: Lx65x20mm
表面: 氧化铝本色/喷漆 (黑色/白色)
PC罩: 乳白/黑色/亚克力磨砂可选
适用: 47MM软灯带/硬灯条

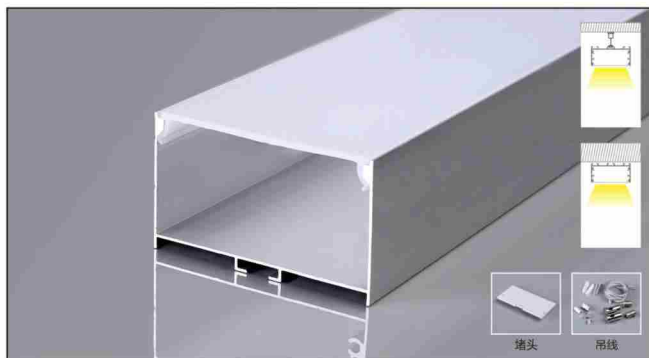
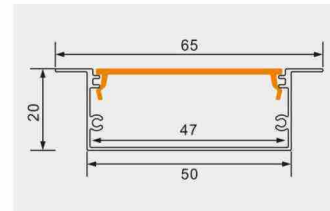

XT750

产品参数 **3520**

尺寸: Lx35x20mm
表面: 氧化铝本色/喷漆 (黑色/白色)
PC罩: 乳白
适用: 32MM软灯带/硬灯条

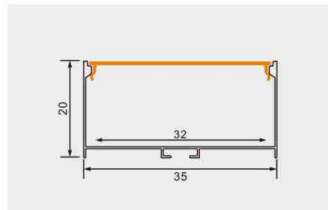

XT749

产品参数 **3520带边**

尺寸: Lx49x20mm
表面: 氧化铝本色/喷漆 (黑色/白色)
PC罩: 乳白
适用: 32MM软灯带/硬灯条

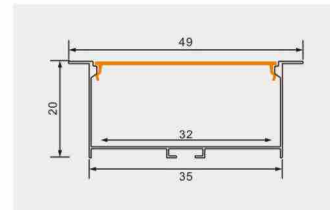

XT435

产品参数 **4020**

尺寸: Lx40x20mm
表面: 氧化铝本色/喷漆 (黑色/白色)
PC罩: 乳白/黑色/亚克力磨砂可选
适用: 37MM软灯带/硬灯条

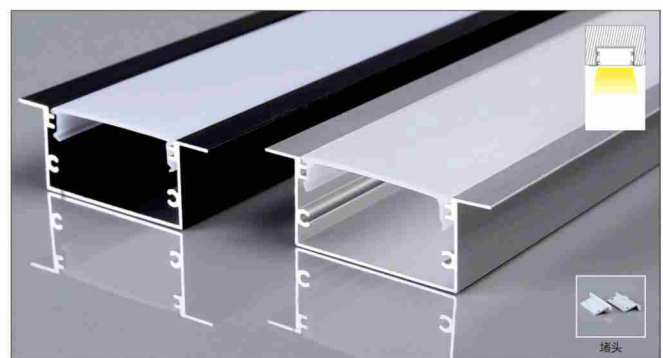
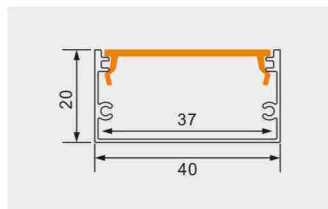

XT436

产品参数 **4020带边**

尺寸: Lx55x20mm
表面: 氧化铝本色/喷漆 (黑色/白色)
PC罩: 乳白/黑色/亚克力磨砂可选
适用: 37MM软灯带/硬灯条

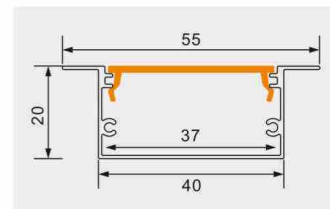

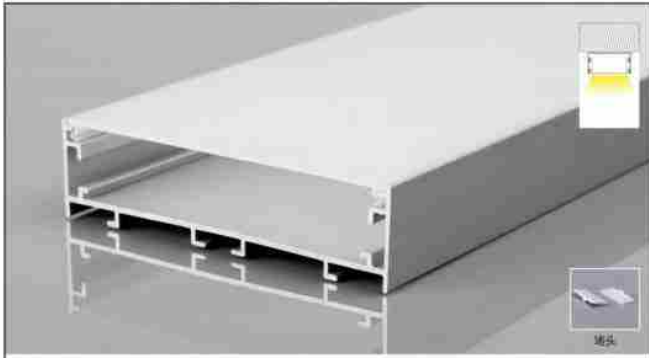

BG149

产品参数 **7520**

尺寸: Lx75x20mm
 表面: 氧化铝本色/喷漆 (黑色/白色)
 PC罩: 乳白/黑色/亚克力磨砂可选
 适用: 66MM软灯带/硬灯条

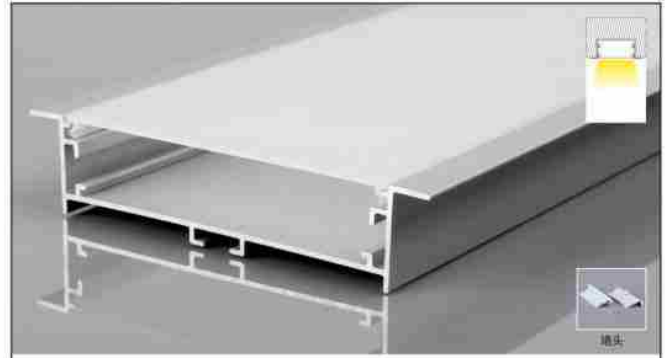
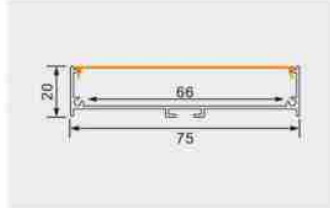

BG150

产品参数 **7520带边**

尺寸: Lx90x20mm
 表面: 氧化铝本色/喷漆 (黑色/白色)
 PC罩: 乳白/黑色/亚克力磨砂可选
 适用: 66MM软灯带/硬灯条

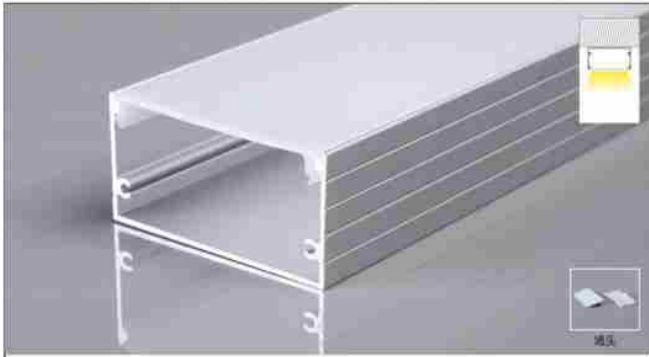
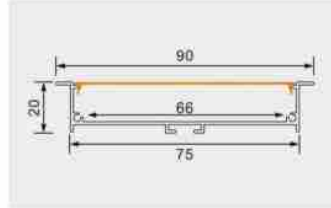

XT350

产品参数 **5025**

尺寸: Lx50x25mm
 表面: 氧化铝本色/喷漆 (黑色/白色)
 PC罩: 乳白/黑色/亚克力磨砂可选
 适用: 47MM软灯带/硬灯条

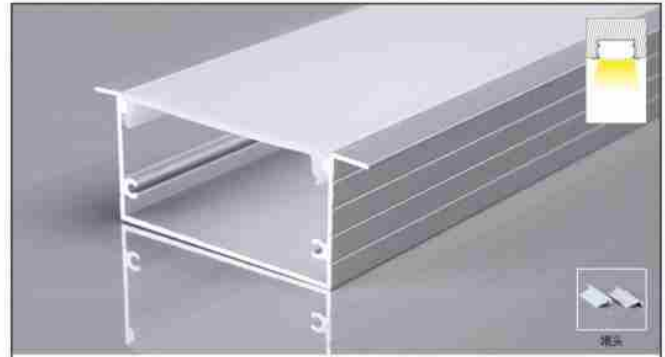
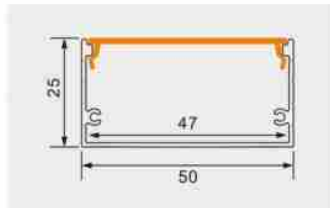

XT356

产品参数 **5025带边**

尺寸: Lx65x20mm
 表面: 氧化铝本色/喷漆 (黑色/白色)
 PC罩: 乳白/黑色/亚克力磨砂可选
 适用: 47MM软灯带/硬灯条

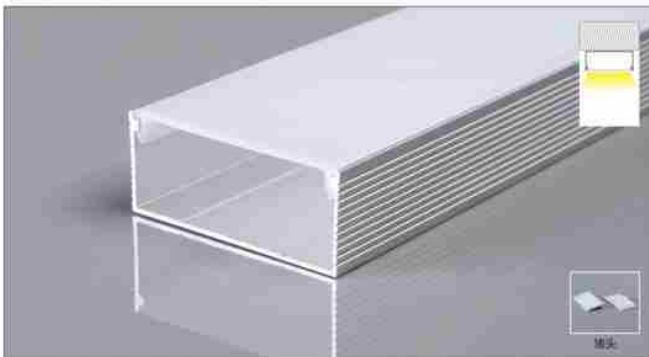
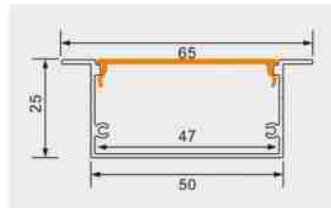

XT296

产品参数 **4820**

尺寸: Lx48x20mm
 表面: 氧化铝本色/喷漆 (黑色/白色)
 PC罩: 乳白/黑色/亚克力磨砂可选
 适用: 45MM软灯带/硬灯条

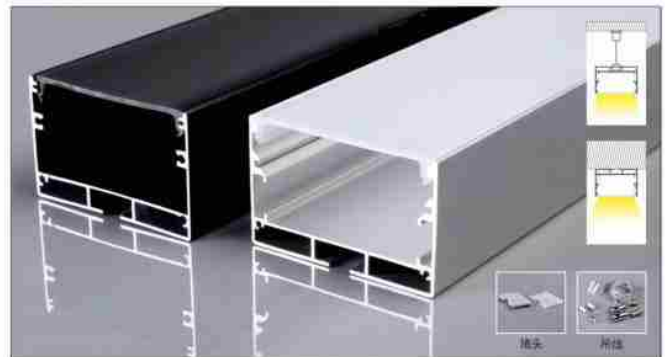
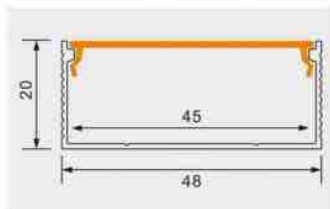

XT399

产品参数 **5032**

尺寸: Lx49x32mm
 表面: 氧化铝本色/喷漆 (黑色/白色)
 PC罩: 乳白/黑色/亚克力磨砂可选
 适用: 46MM软灯带/硬灯条

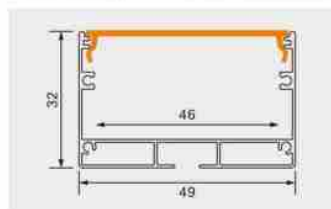

P16-P18

弧面/三面发光

铝型材套件

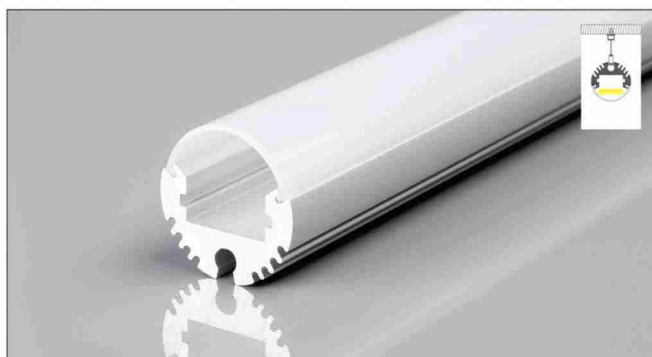
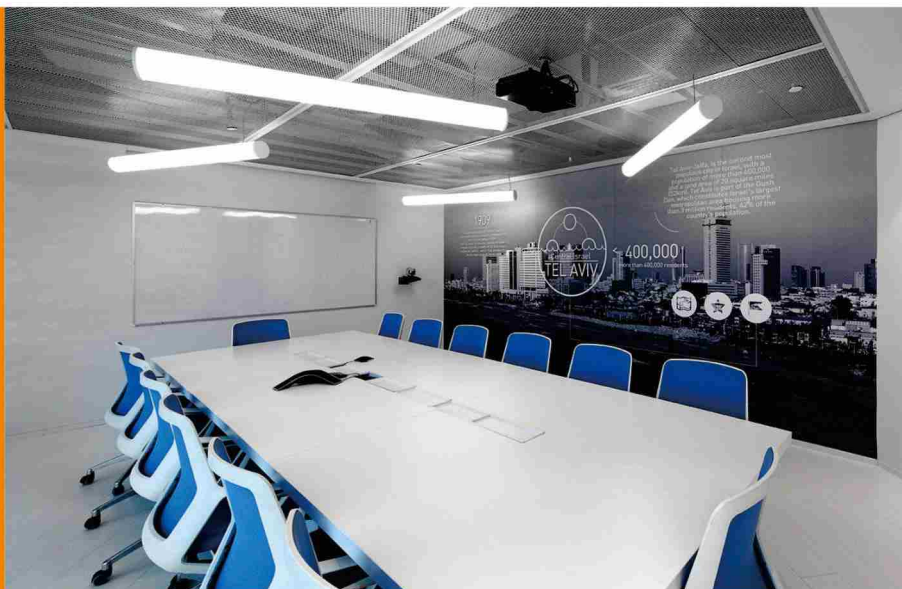

XT239

产品参数

尺寸: LxØ20mm
表面: 氧化铝本色/喷漆 (黑色/白色)
PC罩: 乳白
适用: 12MM软灯带/硬灯条

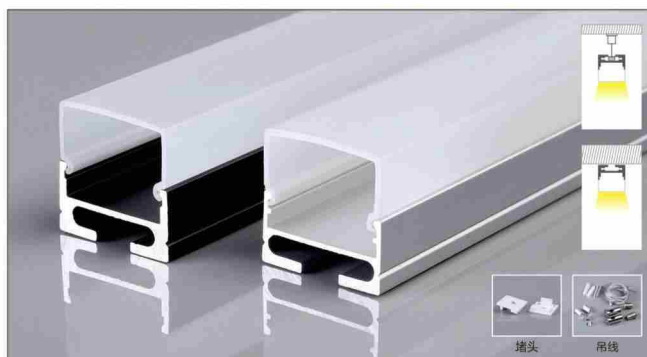
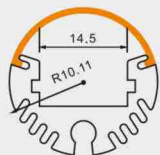

XT437

产品参数 2020三面发光

尺寸: Lx20x20mm
表面: 氧化铝本色/喷漆 (黑色/白色)
PC罩: 乳白
适用: 16MM软灯带/硬灯条

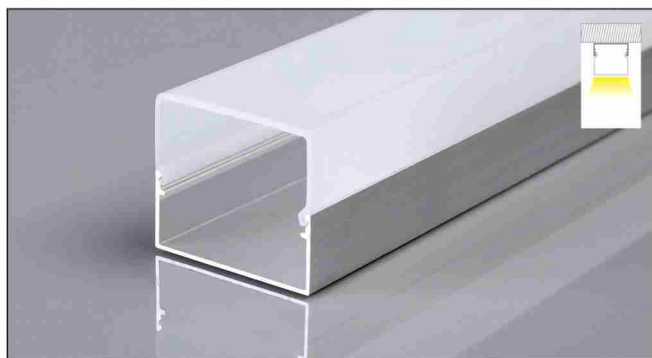
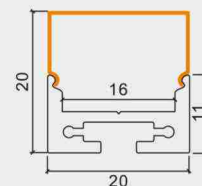

XT491

产品参数 2020三面发光

尺寸: Lx20x20mm
表面: 氧化铝本色/喷漆 (黑色/白色)
PC罩: 乳白
适用: 18MM软灯带/硬灯条

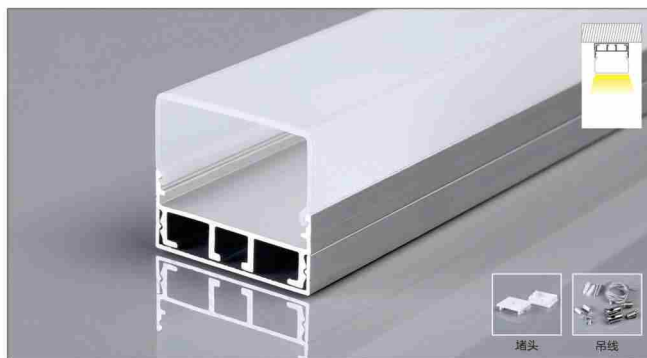
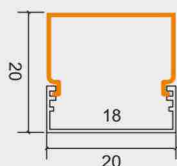

XT66+69

产品参数 2825三面发光

尺寸: Lx28x25mm
表面: 氧化铝本色/喷漆 (黑色/白色)
PC罩: 乳白
适用: 25MM软灯带/硬灯条

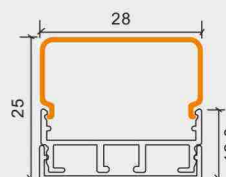

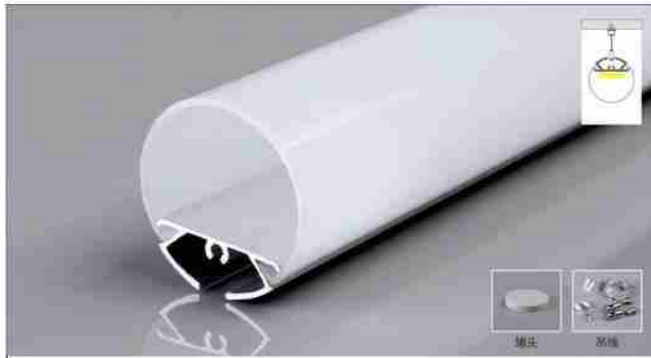

XT290

产品参数 **30小圆**

尺寸: LxØ30mm
 表面: 氧化铝本色/喷漆 (黑色/白色)
 PC罩: 乳白
 适用: 20MM软灯带/硬灯条

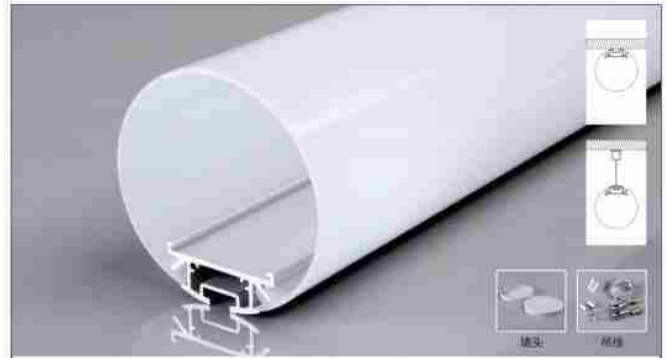
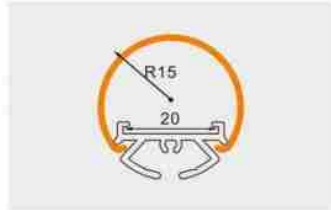

XT230

产品参数 **60大圆**

尺寸: LxØ60mm
 表面: 氧化铝本色/喷漆 (黑色/白色)
 PC罩: 乳白
 适用: 30MM软灯带/硬灯条

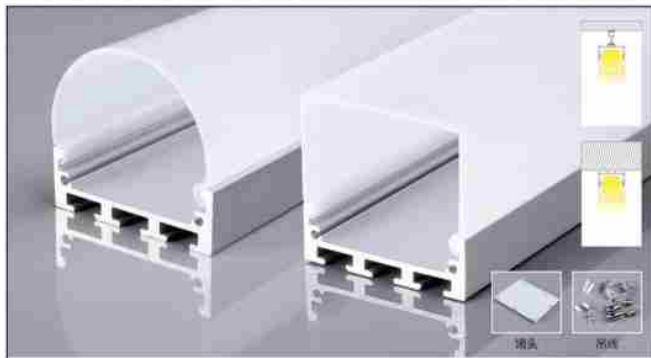
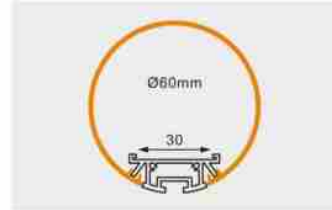

XT303方/半圆

产品参数 **4542三面发光**

尺寸: Lx45x42mm
 表面: 氧化铝本色/喷漆 (黑色/白色)
 PC罩: 乳白
 适用: 34MM软灯带/硬灯条

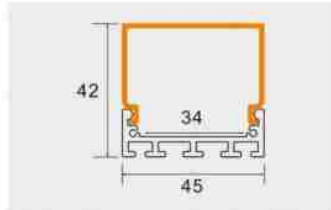

RG508

产品参数 **3860三面发光**

尺寸: Lx38x60mm
 表面: 氧化铝本色/喷漆 (黑色/白色)
 PC罩: 乳白
 适用: 10MM软灯带/硬灯条

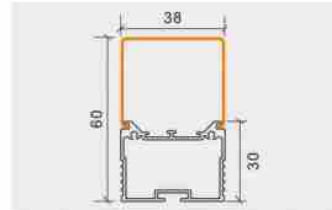

XT302

产品参数 **4070三面发光**

尺寸: Lx40x70mm
 表面: 氧化铝本色/喷漆 (黑色/白色)
 PC罩: 乳白
 适用: 30MM软灯带/硬灯条

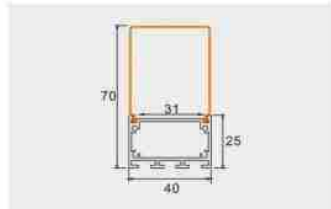

XT305

产品参数 **4550三面发光**

尺寸: Lx45x50mm
 表面: 氧化铝本色/喷漆 (黑色/白色)
 PC罩: 乳白
 适用: 36MM软灯带/硬灯条

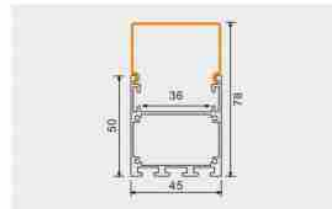

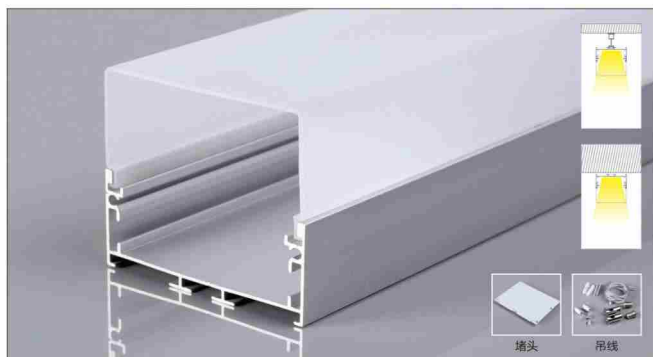

BG77

产品参数 **5045三面发光**

尺寸: Lx50x45mm
表面: 氧化铝本色/喷漆 (黑色/白色)
PC罩: 乳白
适用: 40MM软灯带/硬灯条

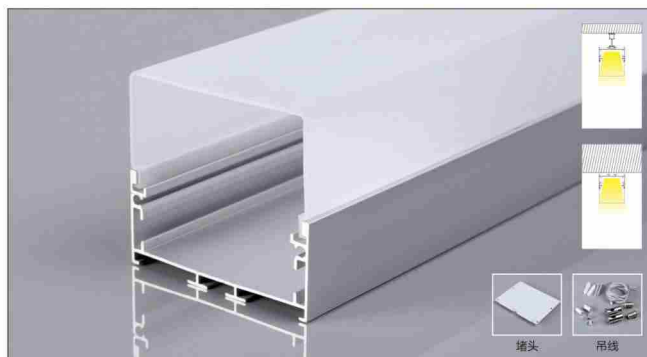
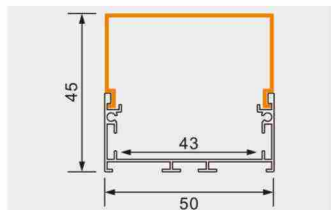

BG45

产品参数 **4045三面发光**

尺寸: Lx40x45mm
表面: 氧化铝本色/喷漆 (黑色/白色)
PC罩: 乳白
适用: 30MM软灯带/硬灯条

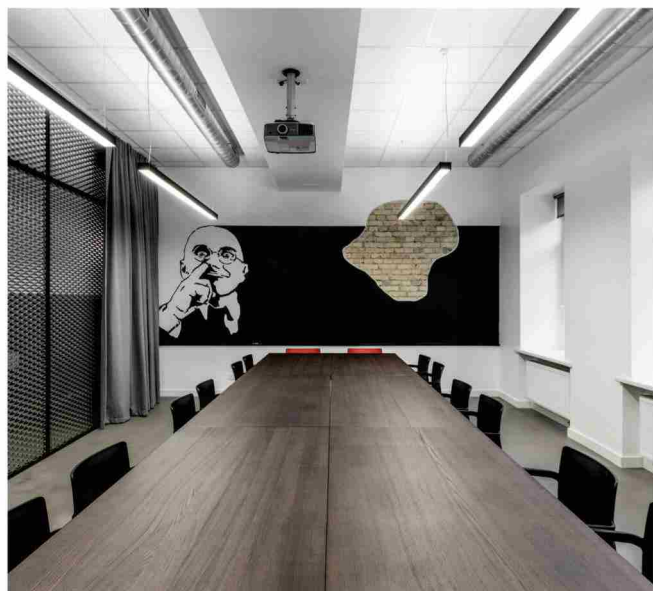
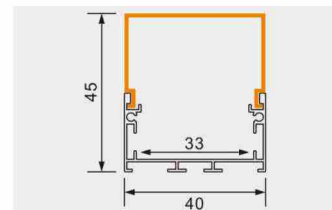

BG78

产品参数 **6065三面发光**

尺寸: Lx60x65mm
表面: 氧化铝本色/喷漆 (黑色/白色)
PC罩: 乳白
适用: 35MM软灯带/硬灯条

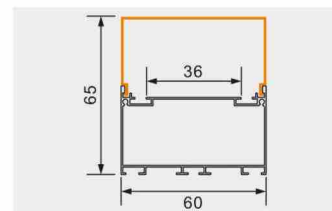

BG79

产品参数 **7070三面发光**

尺寸: Lx70x70mm
表面: 氧化铝本色/喷漆 (黑色/白色)
PC罩: 乳白
适用: 45MM软灯带/硬灯条

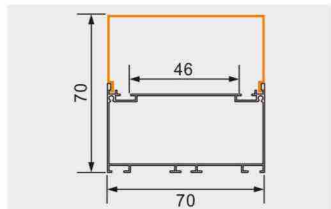

BG80

产品参数 **8075三面发光**

尺寸: Lx80x75mm
表面: 氧化铝本色/喷漆 (黑色/白色)
PC罩: 乳白
适用: 55MM软灯带/硬灯条

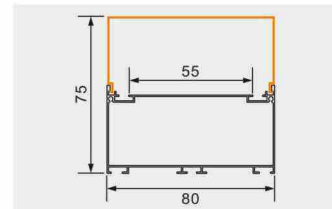

P19-P28

办公灯系列

铝型材套件

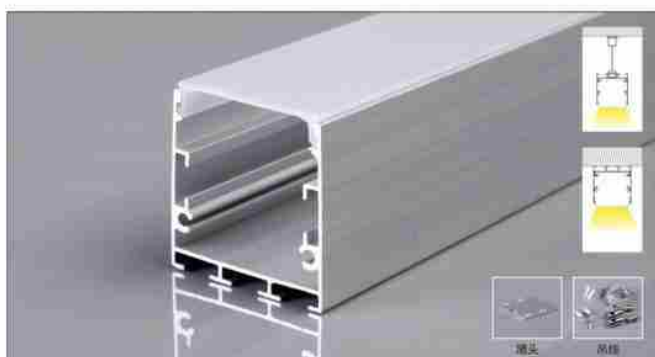

BG87

产品参数 **3535**

尺寸: Lx35x35mm
表面: 氧化铝本色/喷漆 (黑色/白色)
PC罩: 乳白/黑色/亚克力磨砂可选
适用: 32MM软灯带/硬灯条

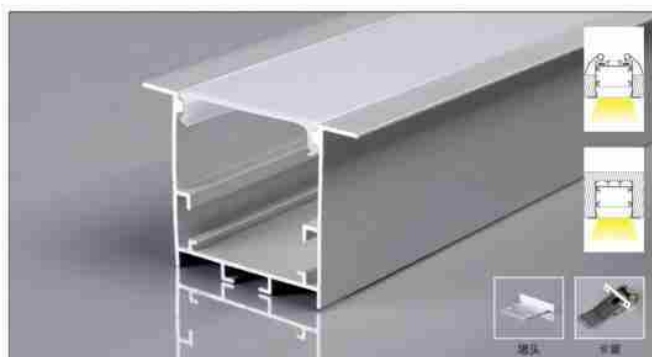
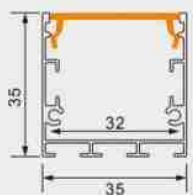

BG86

产品参数 **3535带边**

尺寸: Lx50x35mm
表面: 氧化铝本色/喷漆 (黑色/白色)
PC罩: 乳白/黑色/亚克力磨砂可选
适用: 32MM软灯带/硬灯条

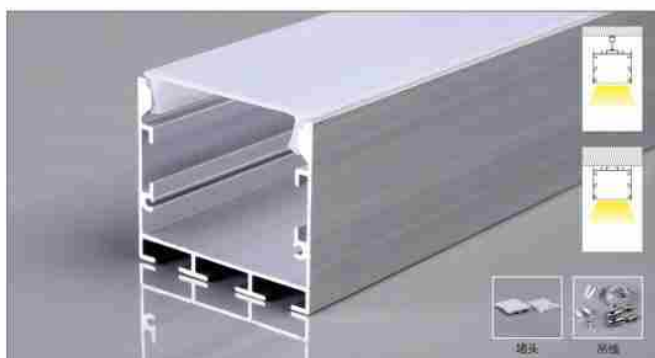
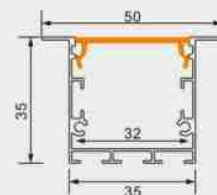

BG40

产品参数 **4035**

尺寸: Lx40x35mm
表面: 氧化铝本色/喷漆 (黑色/白色)
PC罩: 乳白/黑色/亚克力磨砂可选
适用: 35MM软灯带/硬灯条

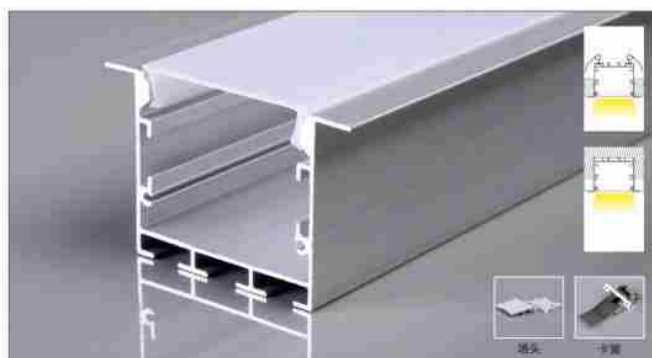
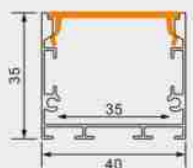

BG47

产品参数 **4035带边**

尺寸: Lx54x35mm
表面: 氧化铝本色/喷漆 (黑色/白色)
PC罩: 乳白/黑色/亚克力磨砂可选
适用: 35MM软灯带/硬灯条

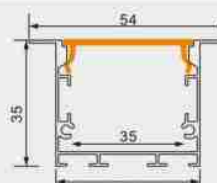

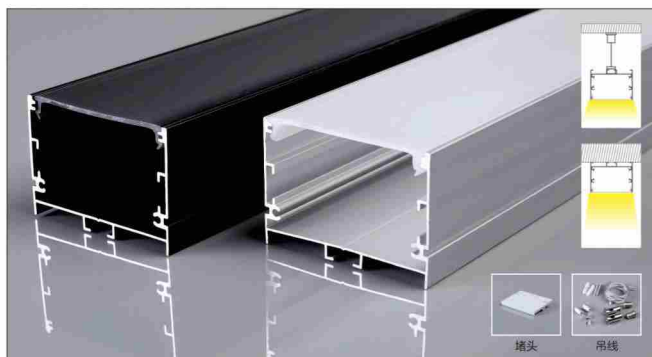

BG85

产品参数 **5035**

尺寸: Lx50x35mm
表面: 氧化铝本色/喷漆 (黑色/白色)
PC罩: 乳白/黑色/亚克力磨砂可选
适用: 42MM软灯带/硬灯条

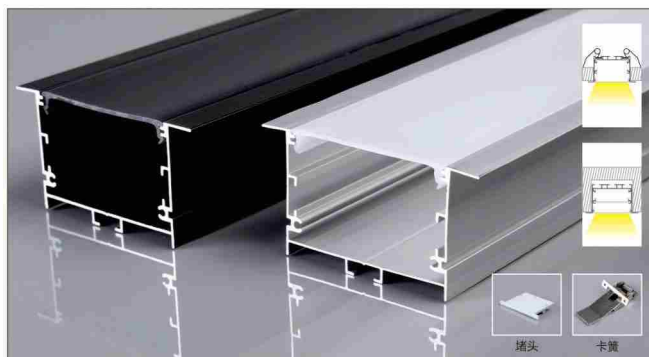
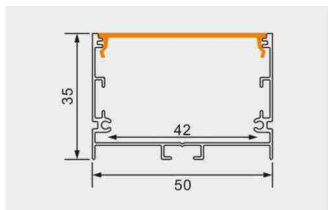

BG84

产品参数 **5035带边**

尺寸: Lx66x35mm
表面: 氧化铝本色/喷漆 (黑色/白色)
PC罩: 乳白/黑色/亚克力磨砂可选
适用: 42MM软灯带/硬灯条

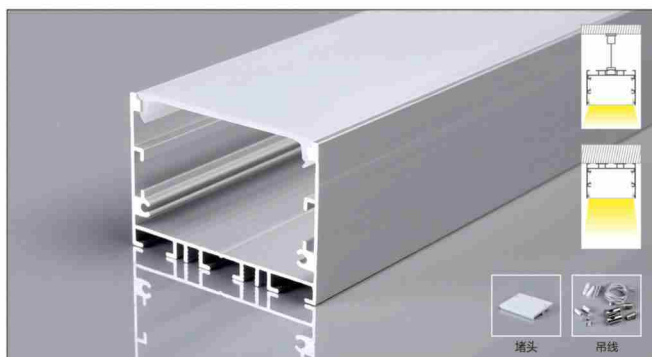
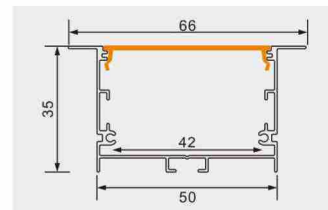

BG63

产品参数 **5035厚款**

尺寸: Lx50x35mm
表面: 氧化铝本色/喷漆 (黑色/白色)
PC罩: 乳白/黑色/亚克力磨砂可选
适用: 42MM软灯带/硬灯条

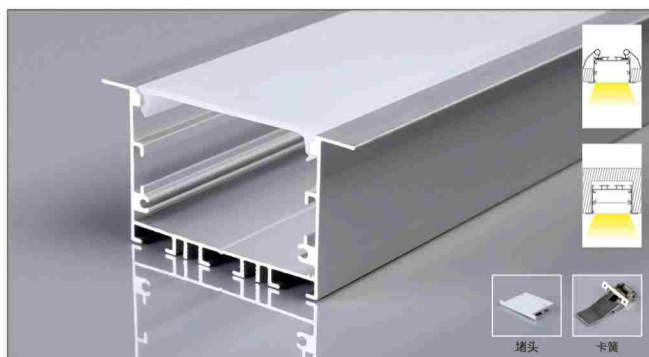
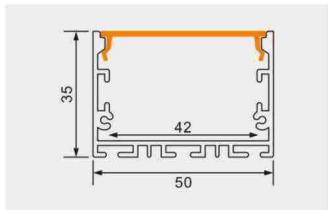

BG64

产品参数 **5035带边厚款**

尺寸: Lx66x35mm
表面: 氧化铝本色/喷漆 (黑色/白色)
PC罩: 乳白/黑色/亚克力磨砂可选
适用: 42MM软灯带/硬灯条

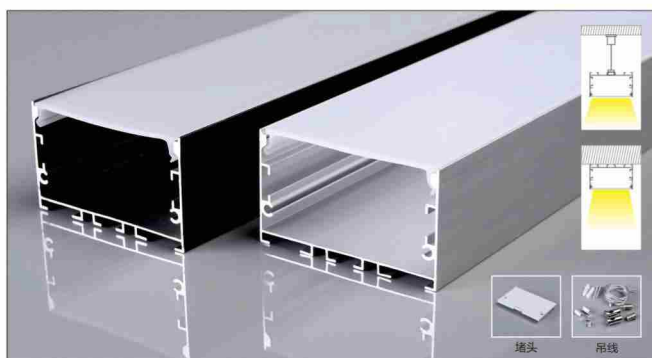
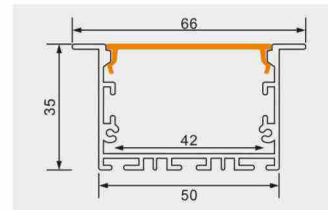

BG89

产品参数 **6035**

尺寸: Lx60x35mm
表面: 氧化铝本色/喷漆 (黑色/白色)
PC罩: 乳白
适用: 52MM软灯带/硬灯条

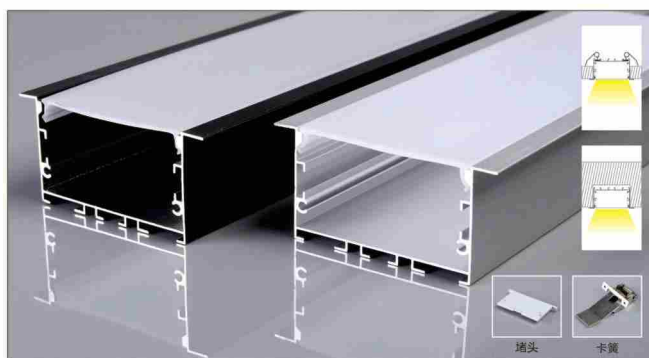
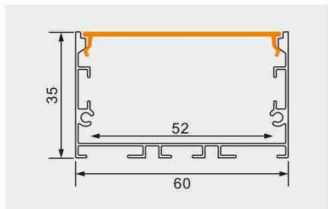

BG90

产品参数 **6035带边**

尺寸: Lx75x35mm
表面: 氧化铝本色/喷漆 (黑色/白色)
PC罩: 乳白
适用: 52MM软灯带/硬灯条

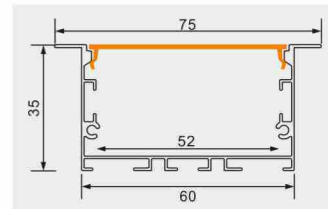

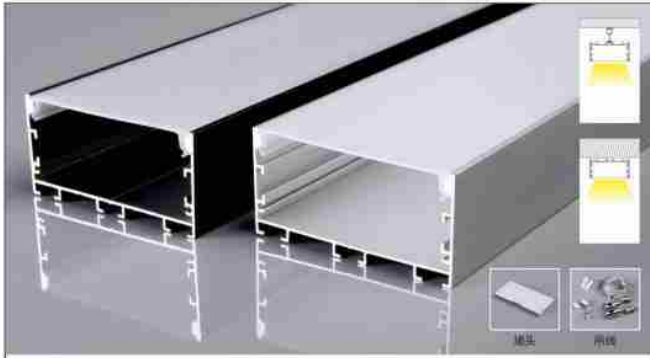

BG88

产品参数 **7035**

尺寸: Lx70x35mm
 表面: 氧化铝本色/喷漆 (黑色/白色)
 PC罩: 乳白
 适用: 62MM软灯带/硬灯条

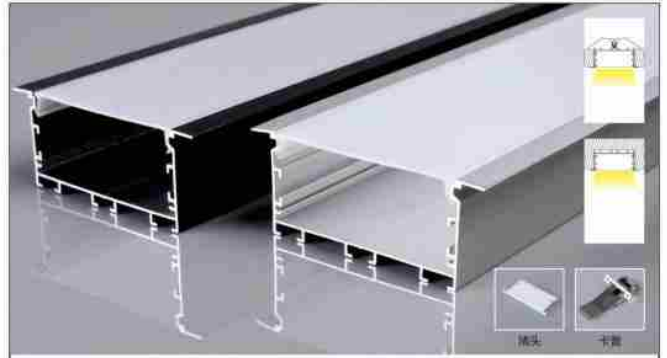
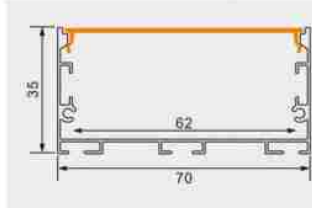

BG83

产品参数 **7035带边**

尺寸: Lx86x35mm
 表面: 氧化铝本色/喷漆 (黑色/白色)
 PC罩: 乳白
 适用: 62MM软灯带/硬灯条

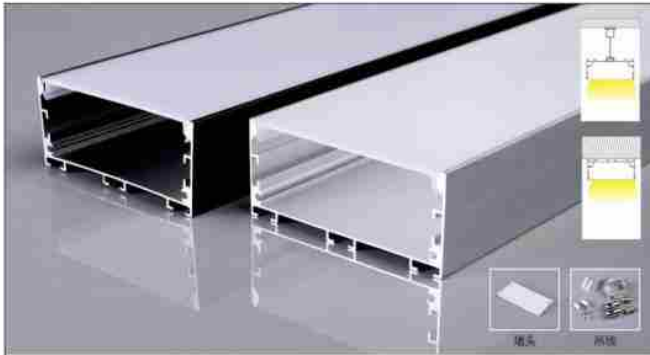
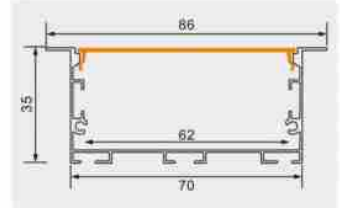

BG29

产品参数 **7535**

尺寸: Lx80x35mm
 表面: 氧化铝本色/喷漆 (黑色/白色)
 PC罩: 乳白
 适用: 72MM软灯带/硬灯条

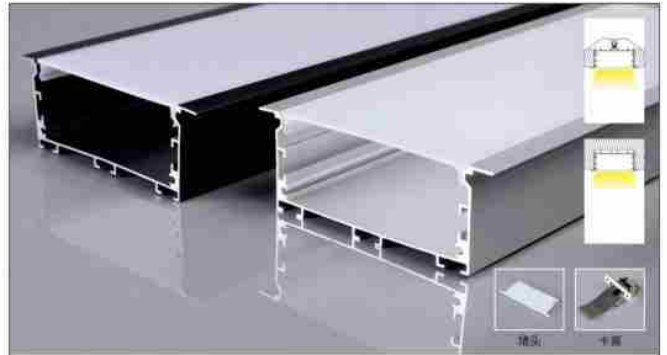
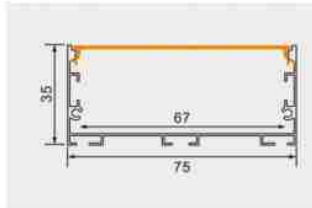

BG30

产品参数 **7535带边**

尺寸: Lx95x35mm
 表面: 氧化铝本色/喷漆 (黑色/白色)
 PC罩: 乳白
 适用: 72MM软灯带/硬灯条

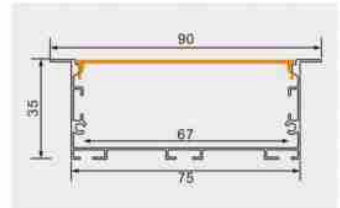

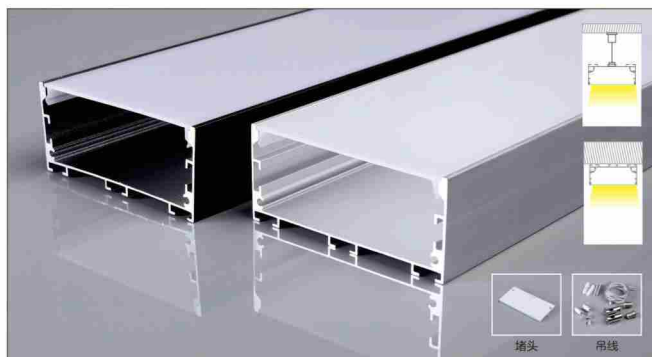

BG69

产品参数 **8035**

尺寸: Lx80x35mm
表面: 氧化铝本色/喷漆 (黑色/白色)
PC罩: 乳白
适用: 72MM软灯带/硬灯条

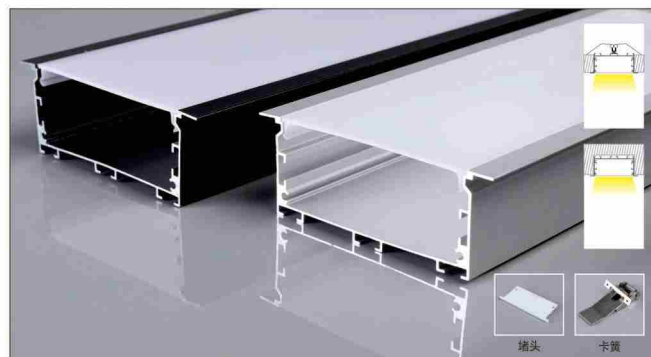
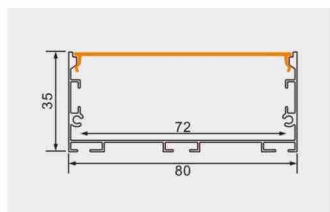

BG70

产品参数 **8035带边**

尺寸: Lx95x35mm
表面: 氧化铝本色/喷漆 (黑色/白色)
PC罩: 乳白
适用: 72MM软灯带/硬灯条

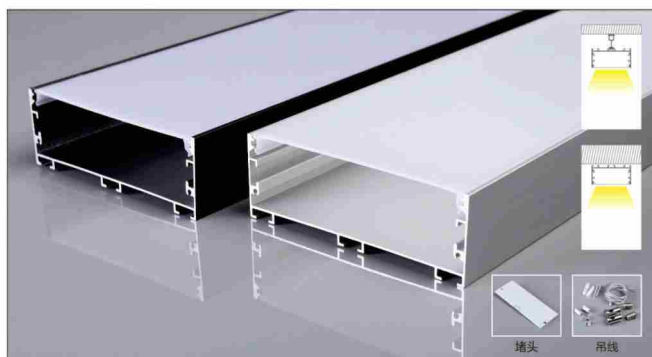
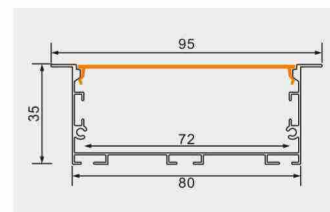

BG157

产品参数 **9035**

尺寸: Lx100x35mm
表面: 氧化铝本色/喷漆 (黑色/白色)
PC罩: 乳白
适用: 92MM软灯带/硬灯条

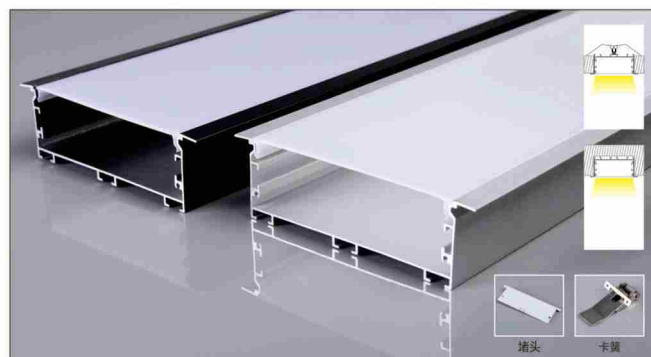

BG158

产品参数 **9035带边**

尺寸: Lx116x35mm
表面: 氧化铝本色/喷漆 (黑色/白色)
PC罩: 乳白
适用: 92MM软灯带/硬灯条

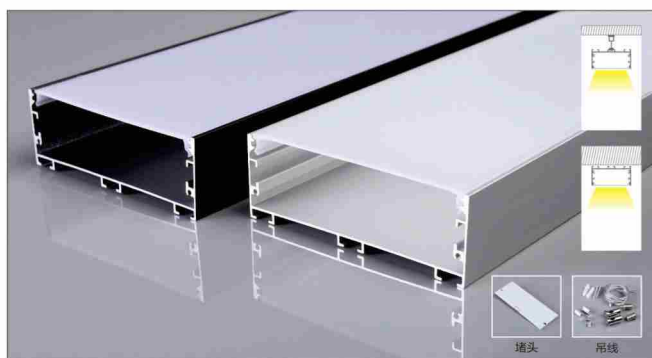
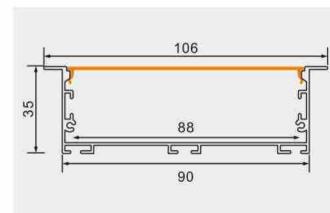

BG56

产品参数 **10035**

尺寸: Lx100x35mm
表面: 氧化铝本色/喷漆 (黑色/白色)
PC罩: 乳白
适用: 92MM软灯带/硬灯条

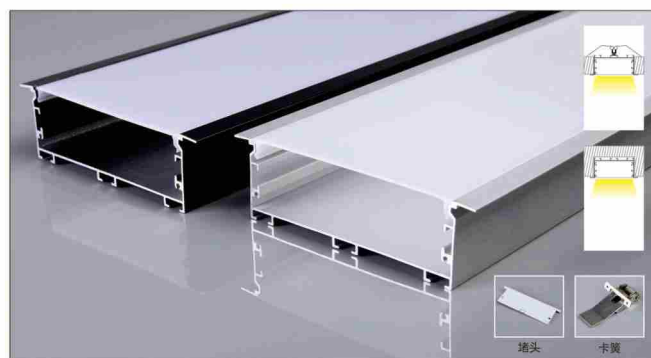
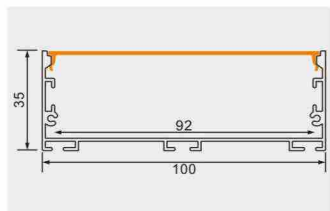

BG57

产品参数 **10035带边**

尺寸: Lx116x35mm
表面: 氧化铝本色/喷漆 (黑色/白色)
PC罩: 乳白
适用: 92MM软灯带/硬灯条

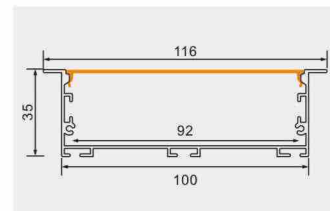

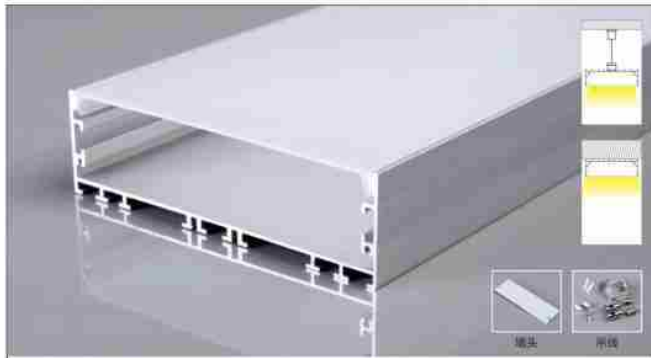

BG61

产品参数 **12035**

尺寸: Lx120x35mm
 表面: 氧化铝本色/喷漆 (黑色/白色)
 PC罩: 乳白
 适用: 110MM软灯带/硬灯条

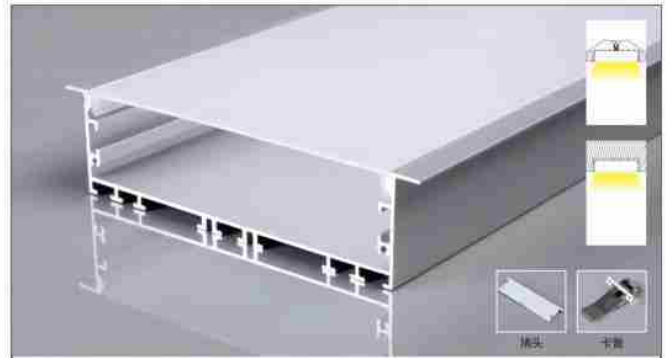
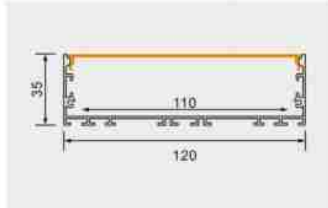

BG62

产品参数 **12035带边**

尺寸: Lx135x35mm
 表面: 氧化铝本色/喷漆 (黑色/白色)
 PC罩: 乳白
 适用: 110MM软灯带/硬灯条

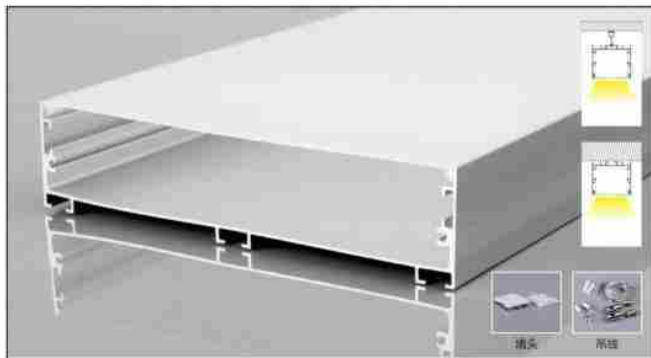
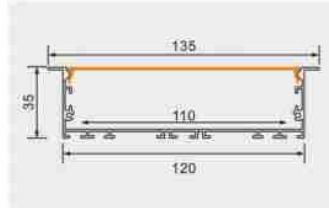

WR15035

产品参数 **15035**

尺寸: Lx150x35mm
 表面: 氧化铝本色/喷漆 (黑色/白色)
 PC罩: 乳白/黑色/亚克力磨砂可选
 适用: 138MM软灯带/硬灯条

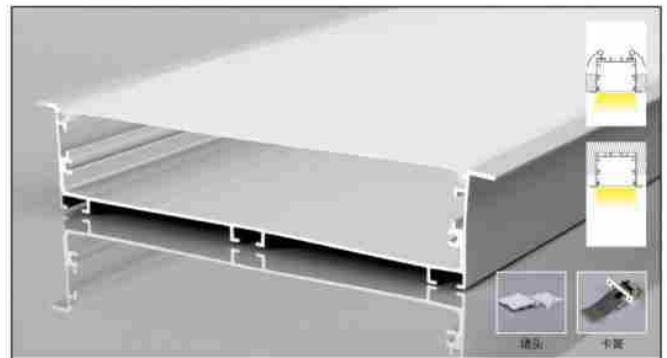
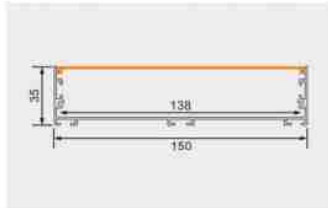

WR15035DB

产品参数 **15035带边**

尺寸: Lx166x35mm
 表面: 氧化铝本色/喷漆 (黑色/白色)
 PC罩: 乳白/黑色/亚克力磨砂可选
 适用: 138MM软灯带/硬灯条

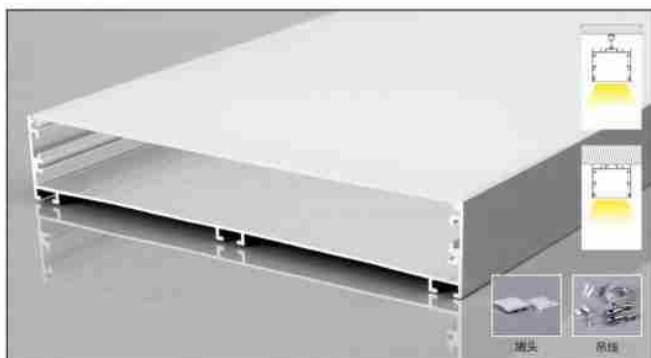
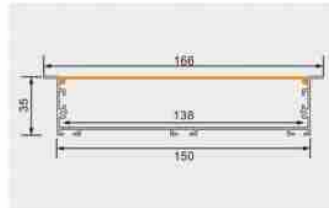

WR20035

产品参数 **20035**

尺寸: Lx200x35mm
 表面: 氧化铝本色/喷漆 (黑色/白色)
 PC罩: 乳白/黑色/亚克力磨砂可选
 适用: 187MM软灯带/硬灯条

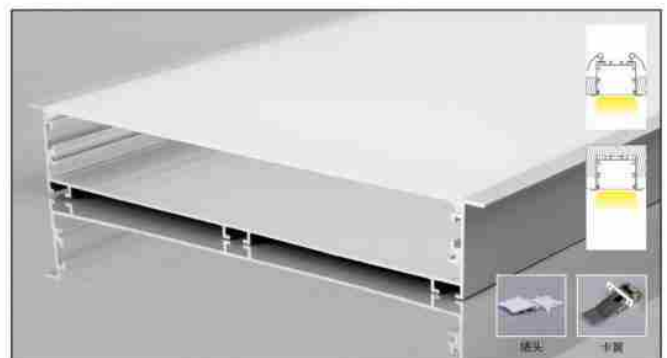
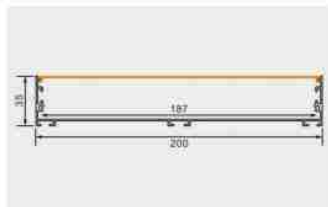

WR20035DB

产品参数 **20035带边**

尺寸: Lx216x35mm
 表面: 氧化铝本色/喷漆 (黑色/白色)
 PC罩: 乳白/黑色/亚克力磨砂可选
 适用: 187MM软灯带/硬灯条

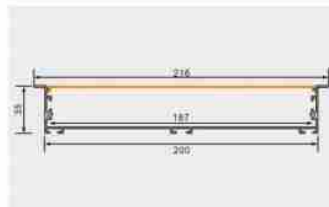

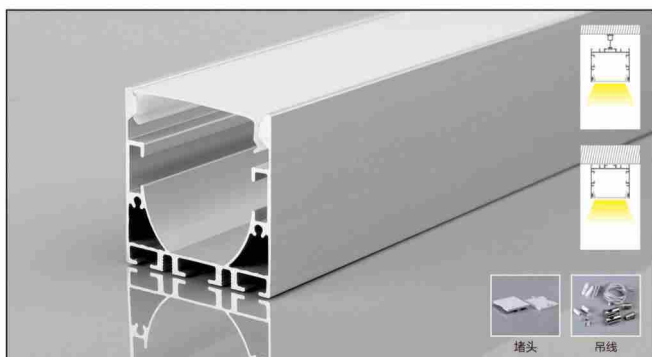

BG01

产品参数 **4040**

尺寸: Lx40x40mm
表面: 氧化铝本色/喷漆 (黑色/白色)
PC罩: 乳白/黑色/亚克力磨砂可选
适用: 15MM软灯带/硬灯条

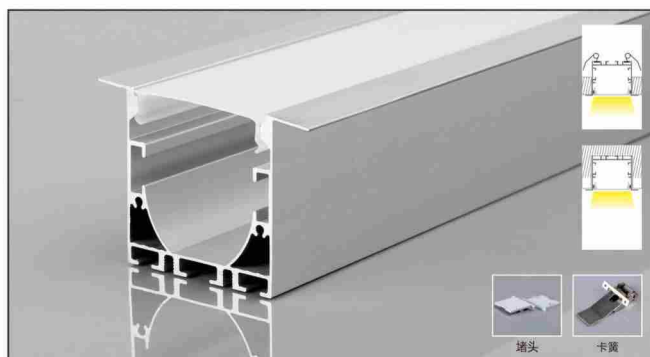
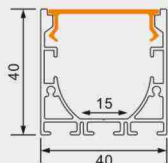

BG09

产品参数 **4040带边**

尺寸: Lx56x40mm
表面: 氧化铝本色/喷漆 (黑色/白色)
PC罩: 乳白/黑色/亚克力磨砂可选
适用: 15MM软灯带/硬灯条

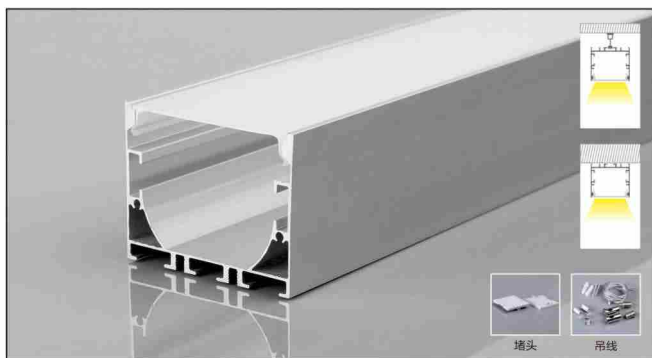
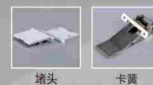
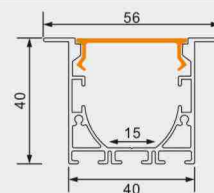

BG02

产品参数 **5040**

尺寸: Lx50x40mm
表面: 氧化铝本色/喷漆 (黑色/白色)
PC罩: 乳白/黑色/亚克力磨砂可选
适用: 26MM软灯带/硬灯条

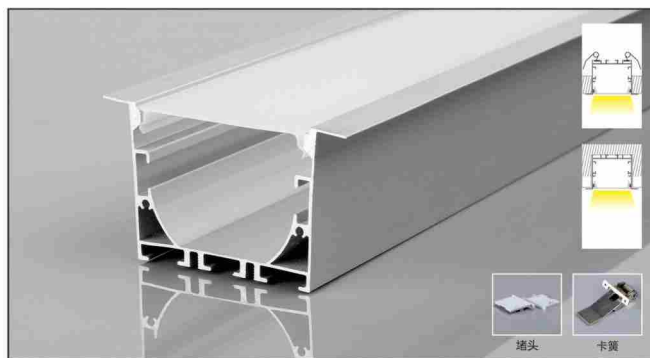
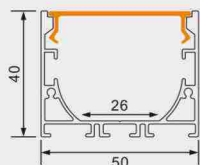

BG10

产品参数 **5040带边**

尺寸: Lx66x40mm
表面: 氧化铝本色/喷漆 (黑色/白色)
PC罩: 乳白/黑色/亚克力磨砂可选
适用: 26MM软灯带/硬灯条

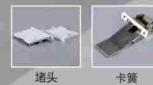
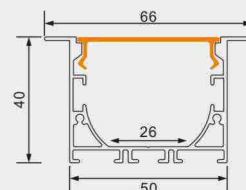

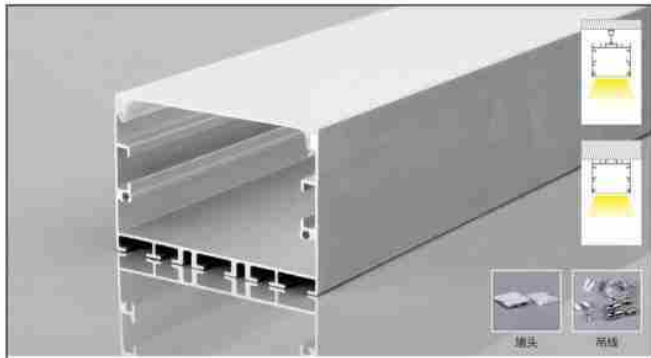

BG50

产品参数 **6040**

尺寸: Lx60x40mm
 表面: 氧化铝本色/喷漆 (黑色/白色)
 PC罩: 乳白/黑色/亚克力磨砂可选
 适用: 58.4MM软灯带/硬灯条

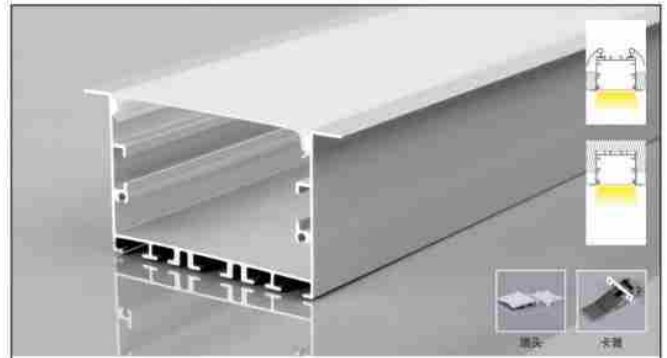
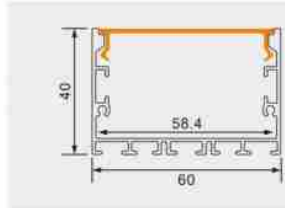

BG52

产品参数 **6040带边**

尺寸: Lx76x40mm
 表面: 氧化铝本色/喷漆 (黑色/白色)
 PC罩: 乳白/黑色/亚克力磨砂可选
 适用: 58.4MM软灯带/硬灯条

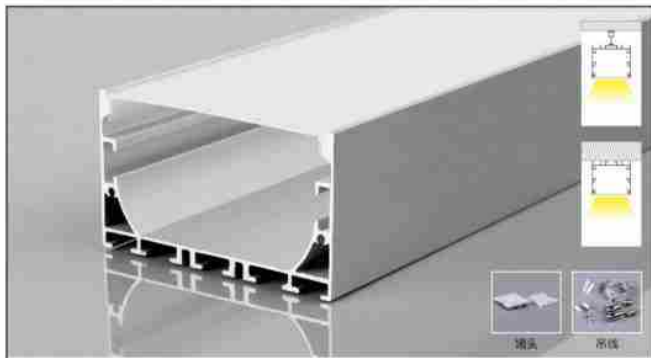
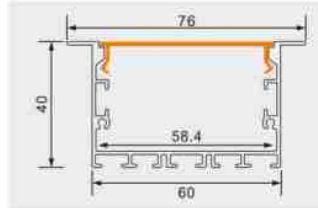

BG03

产品参数 **7040**

尺寸: Lx70x40mm
 表面: 氧化铝本色/喷漆 (黑色/白色)
 PC罩: 乳白/黑色/亚克力磨砂可选
 适用: 45MM软灯带/硬灯条

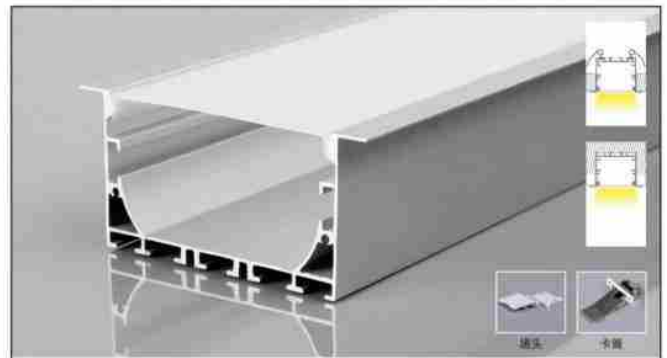
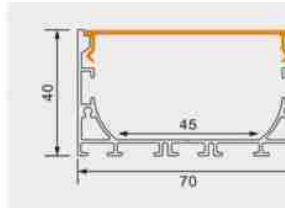

BG11

产品参数 **7040带边**

尺寸: Lx86x40mm
 表面: 氧化铝本色/喷漆 (黑色/白色)
 PC罩: 乳白/黑色/亚克力磨砂可选
 适用: 45MM软灯带/硬灯条

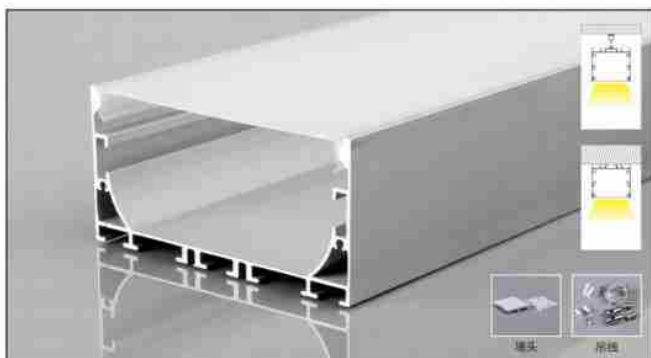
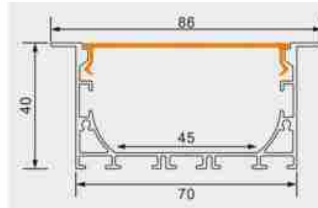

BG04

产品参数 **8040**

尺寸: Lx80x40mm
 表面: 氧化铝本色/喷漆 (黑色/白色)
 PC罩: 乳白/黑色/亚克力磨砂可选
 适用: 55MM软灯带/硬灯条

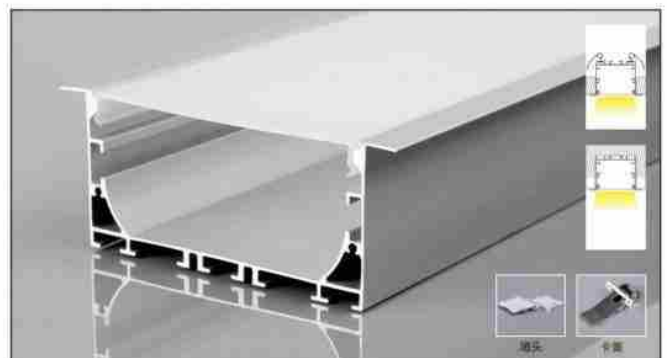
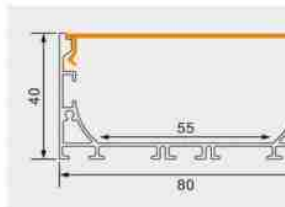

BG12

产品参数 **8040带边**

尺寸: Lx96x40mm
 表面: 氧化铝本色/喷漆 (黑色/白色)
 PC罩: 乳白/黑色/亚克力磨砂可选
 适用: 55MM软灯带/硬灯条

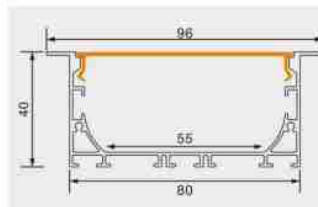

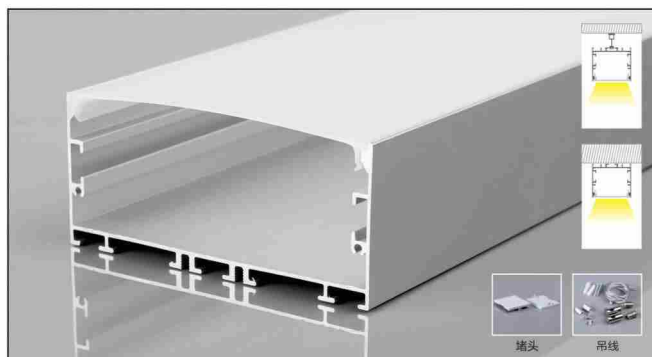

BG51

产品参数 **9040**

尺寸: Lx90x40mm
表面: 氧化铝本色/喷漆 (黑色/白色)
PC罩: 乳白/黑色/亚克力磨砂可选
适用: 88MM软灯带/硬灯条

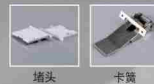
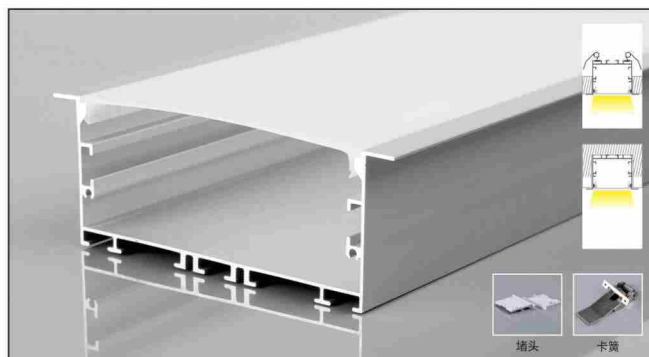
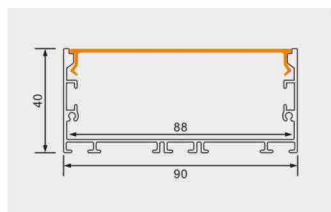

BG53

产品参数 **9040带边**

尺寸: Lx106x40mm
表面: 氧化铝本色/喷漆 (黑色/白色)
PC罩: 乳白/黑色/亚克力磨砂可选
适用: 88MM软灯带/硬灯条

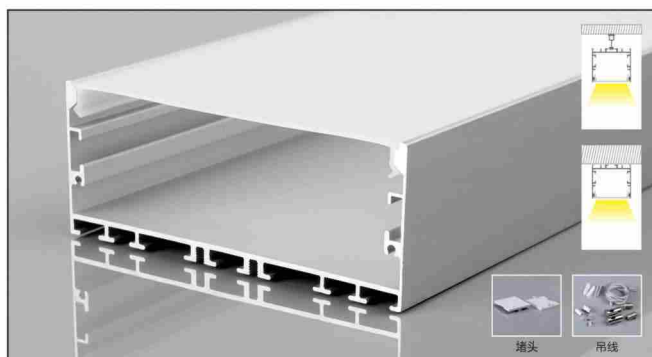
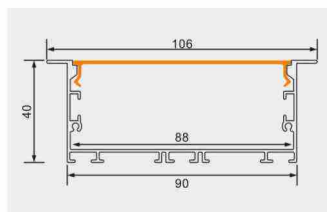

BG05

产品参数 **10040**

尺寸: Lx100x40mm
表面: 氧化铝本色/喷漆 (黑色/白色)
PC罩: 乳白/黑色/亚克力磨砂可选
适用: 75MM软灯带/硬灯条

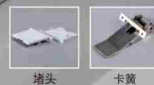
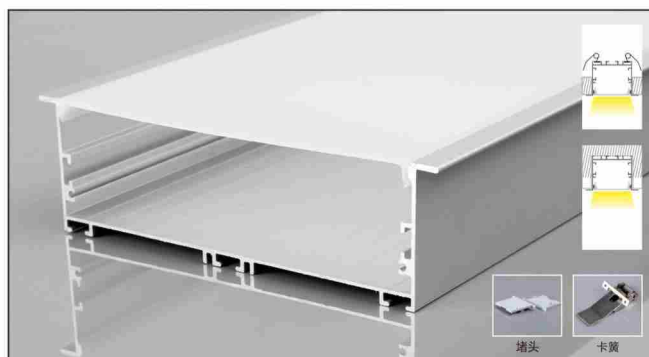
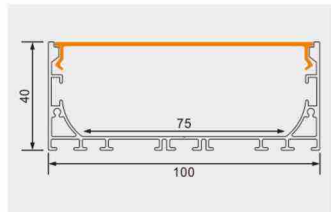

BG13

产品参数 **10040带边**

尺寸: Lx116x40mm
表面: 氧化铝本色/喷漆 (黑色/白色)
PC罩: 乳白/黑色/亚克力磨砂可选
适用: 75MM软灯带/硬灯条

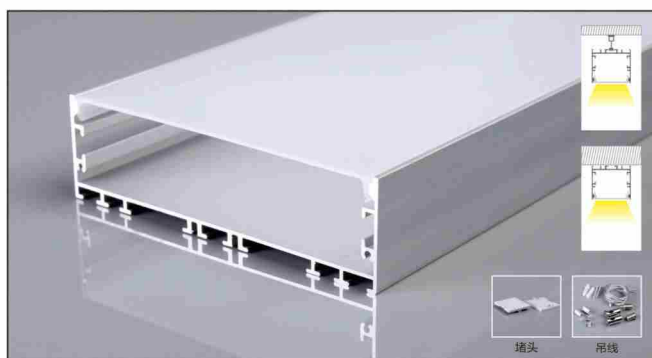
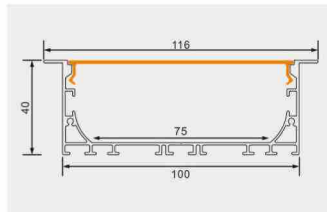

BG06

产品参数 **12040**

尺寸: Lx120x40mm
表面: 氧化铝本色/喷漆 (黑色/白色)
PC罩: 乳白/黑色/亚克力磨砂可选
适用: 95MM软灯带/硬灯条

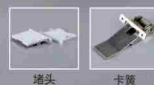
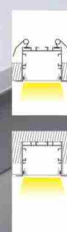
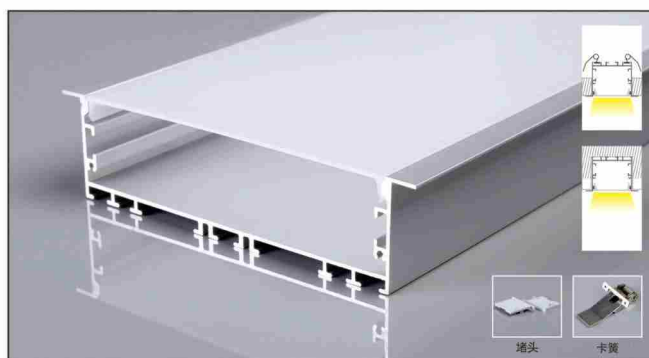
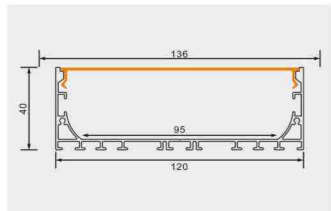

BG14

产品参数 **12040带边**

尺寸: Lx136x40mm
表面: 氧化铝本色/喷漆 (黑色/白色)
PC罩: 乳白/黑色/亚克力磨砂可选
适用: 95MM软灯带/硬灯条

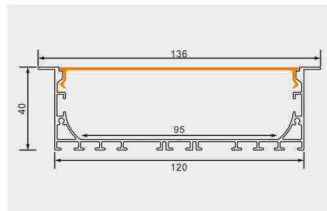

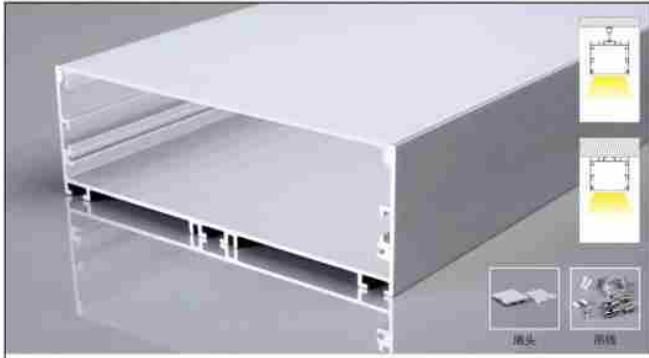

BG07

产品参数 **15040**

尺寸: Lx150x40mm
 表面: 氧化铝本色/喷漆 (黑色/白色)
 PC罩: 乳白/黑色/亚克力磨砂可选
 适用: 125MM软灯带/硬灯条

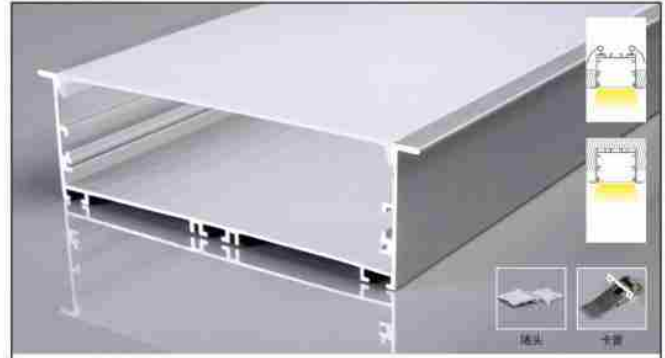
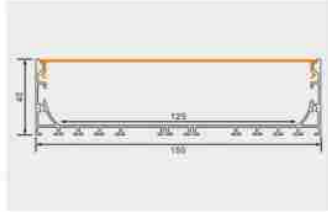

BG15

产品参数 **15040带边**

尺寸: Lx166x40mm
 表面: 氧化铝本色/喷漆 (黑色/白色)
 PC罩: 乳白/黑色/亚克力磨砂可选
 适用: 125MM软灯带/硬灯条

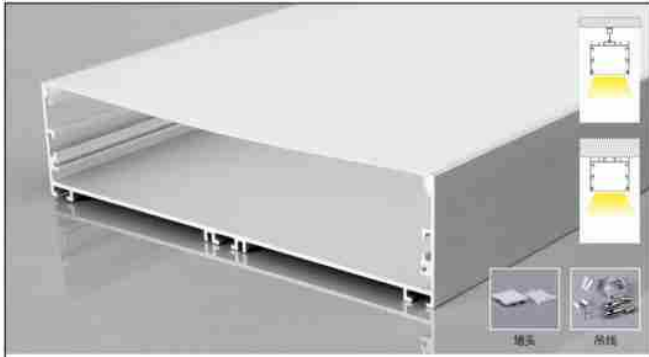
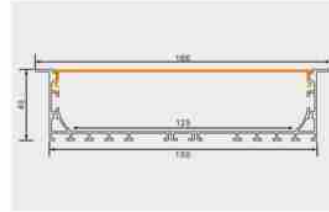

BG08

产品参数 **20040**

尺寸: Lx200x40mm
 表面: 氧化铝本色/喷漆 (黑色/白色)
 PC罩: 乳白/黑色/亚克力磨砂可选
 适用: 175MM软灯带/硬灯条

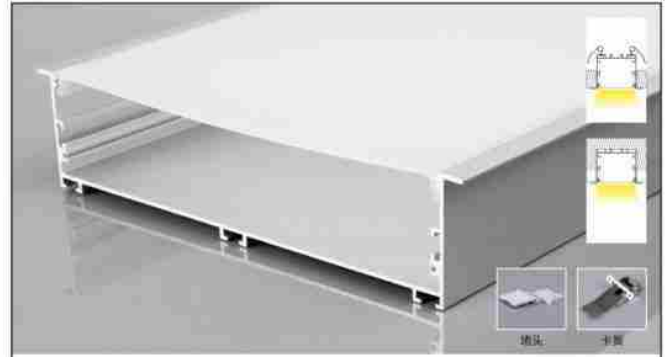

BG16

产品参数 **20040带边**

尺寸: Lx216x40mm
 表面: 氧化铝本色/喷漆 (黑色/白色)
 PC罩: 乳白/黑色/亚克力磨砂可选
 适用: 175MM软灯带/硬灯条

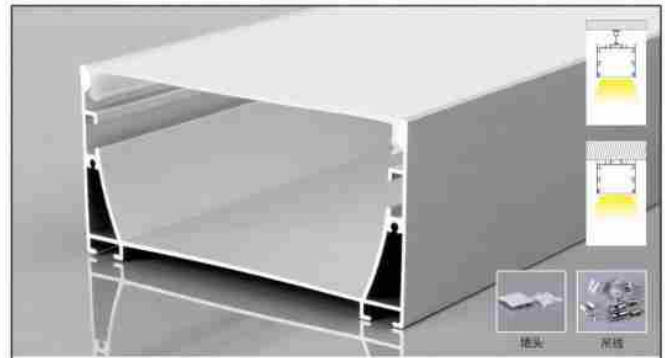
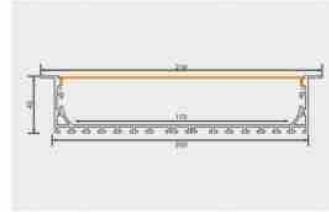

BG82

产品参数 **10050**

尺寸: Lx100x50mm
 表面: 氧化铝本色/喷漆 (黑色/白色)
 PC罩: 乳白/黑色/亚克力磨砂可选
 适用: 75MM软灯带/硬灯条

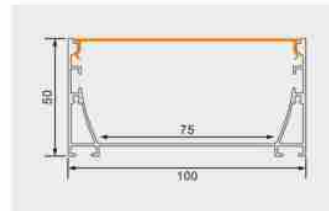

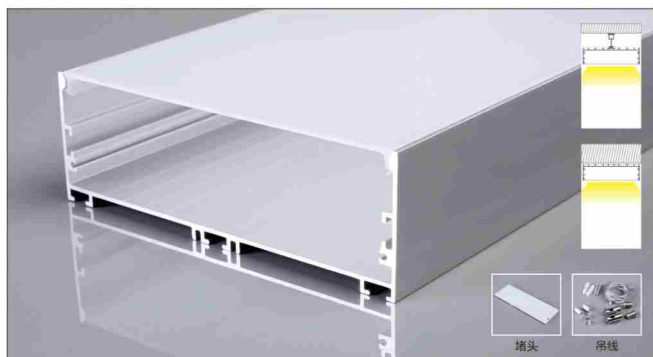

BG116

产品参数 **15050**

尺寸: Lx150x50mm
表面: 氧化铝本色/喷漆 (黑色/白色)
PC罩: 乳白
适用: 140MM软灯带/硬灯条

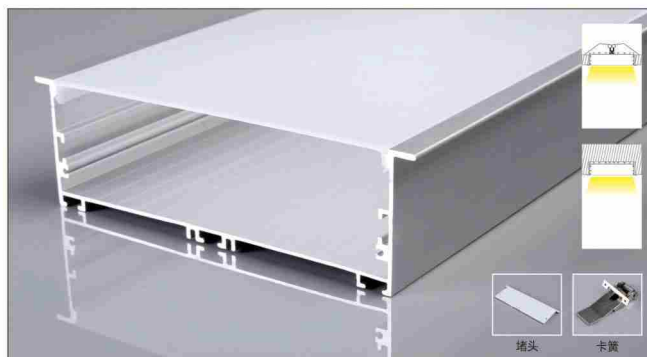
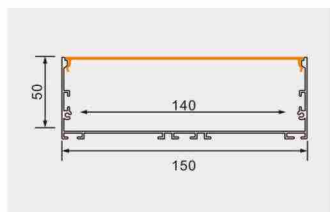

BG117

产品参数 **15050带边**

尺寸: Lx166x50mm
表面: 氧化铝本色/喷漆 (黑色/白色)
PC罩: 乳白
适用: 140MM软灯带/硬灯条

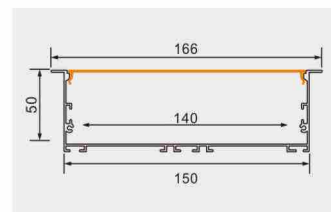

BG118

产品参数 **20050**

尺寸: Lx200x50mm
表面: 氧化铝本色/喷漆 (黑色/白色)
PC罩: 乳白
适用: 185MM软灯带/硬灯条

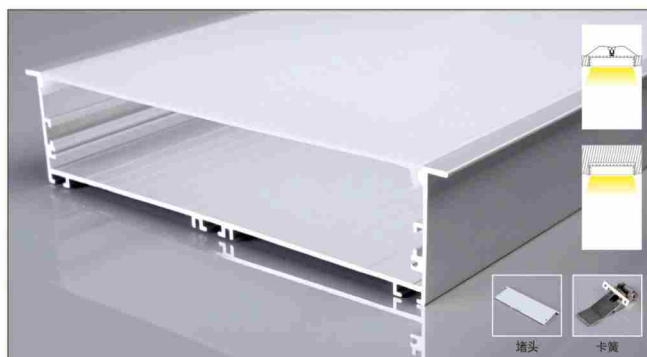
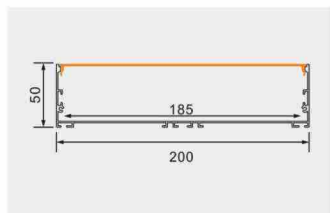

BG119

产品参数 **20050带边**

尺寸: Lx216x50mm
表面: 氧化铝本色/喷漆 (黑色/白色)
PC罩: 乳白
适用: 185MM软灯带/硬灯条

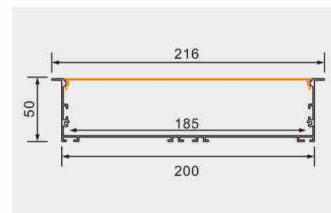

P29-P30

双层办公灯

铝型材套件

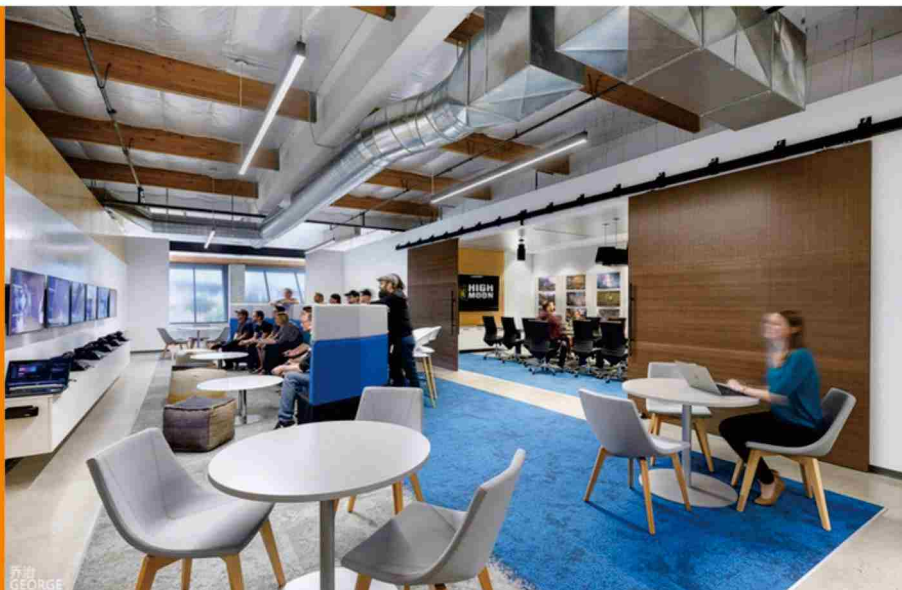

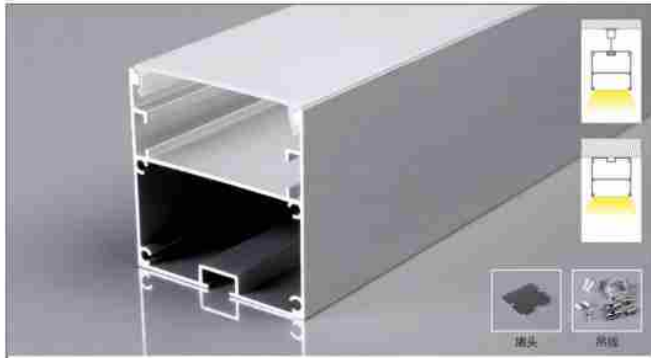

BG97

产品参数 **5050**

尺寸: Lx50x50mm
 表面: 氧化铝本色/喷漆 (黑色/白色)
 PC罩: 乳白/黑色/亚克力磨砂可选
 适用: 38MM软灯带/硬灯条

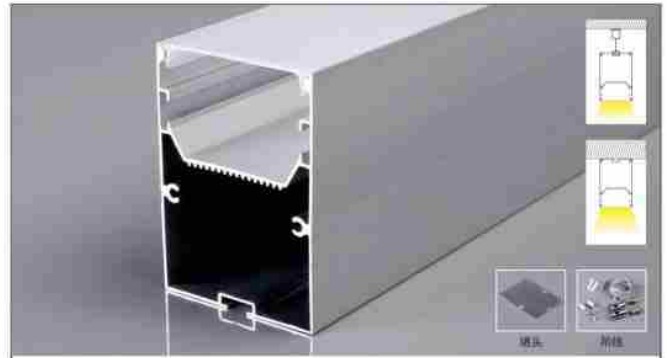
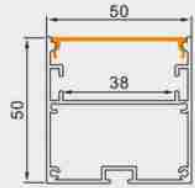

BG95

产品参数 **5070**

尺寸: Lx50x70mm
 表面: 氧化铝本色/喷漆 (黑色/白色)
 PC罩: 乳白/黑色/亚克力磨砂可选
 适用: 32MM软灯带/硬灯条

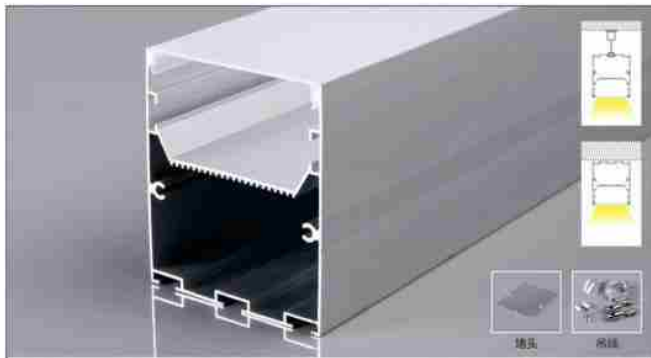

BG96

产品参数 **6070**

尺寸: Lx60x70mm
 表面: 氧化铝本色/喷漆 (黑色/白色)
 PC罩: 乳白
 适用: 42MM软灯带/硬灯条

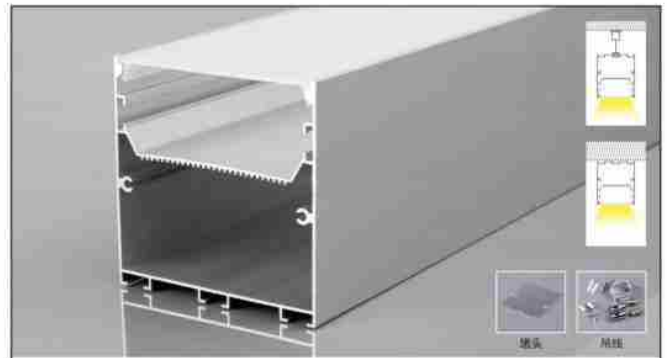
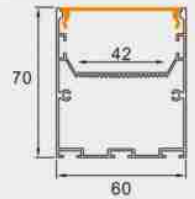

BG111

产品参数 **7575**

尺寸: Lx75x75mm
 表面: 氧化铝本色/喷漆 (黑色/白色)
 PC罩: 乳白
 适用: 57MM软灯带/硬灯条

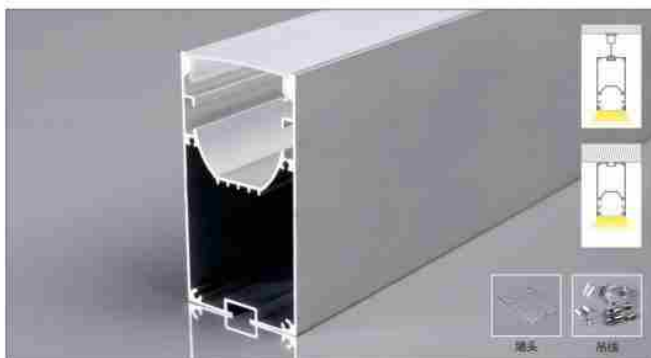
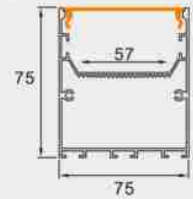

BG17

产品参数 **4075**

尺寸: Lx40x75mm
 表面: 氧化铝本色/喷漆 (黑色/白色)
 PC罩: 乳白/黑色/亚克力磨砂可选
 适用: 15MM软灯带/硬灯条

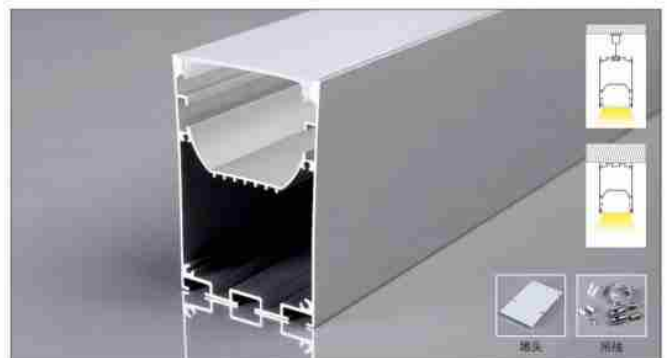
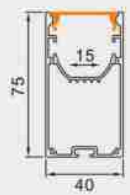

BG18

产品参数 **5075**

尺寸: Lx50x75mm
 表面: 氧化铝本色/喷漆 (黑色/白色)
 PC罩: 乳白/黑色/亚克力磨砂可选
 适用: 25MM软灯带/硬灯条



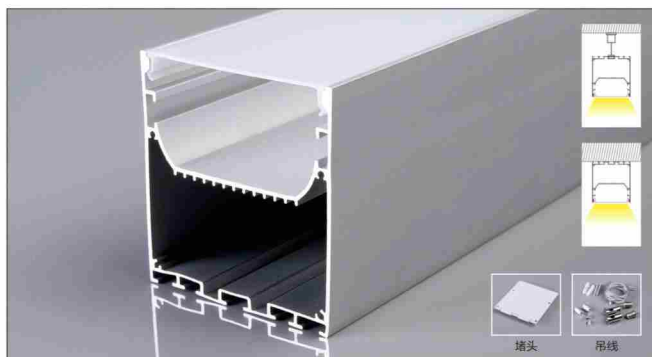

BG19

产品参数 **7075**

尺寸: Lx70x75mm
表面: 氧化铝本色/喷漆 (黑色/白色)
PC罩: 乳白
适用: 45MM软灯带/硬灯条

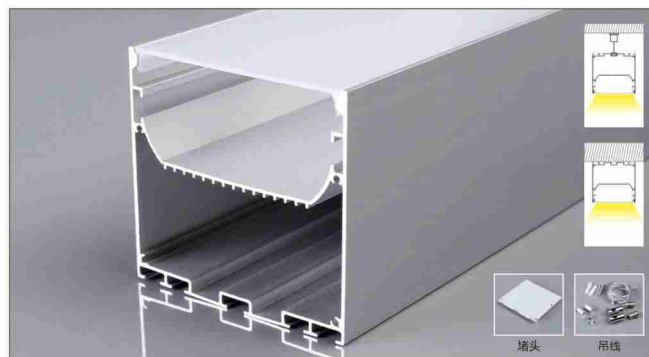
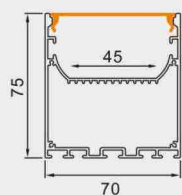

BG20

产品参数 **8075**

尺寸: Lx80x75mm
表面: 氧化铝本色/喷漆 (黑色/白色)
PC罩: 乳白
适用: 55MM软灯带/硬灯条

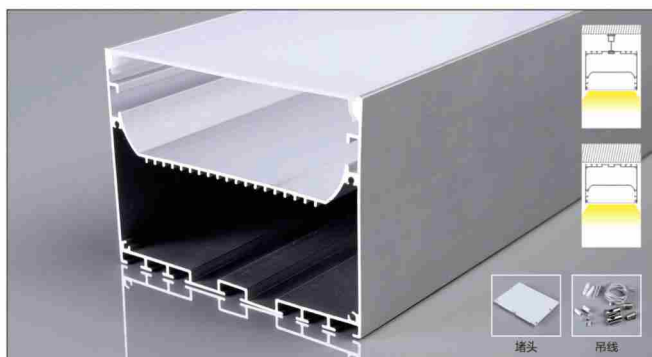
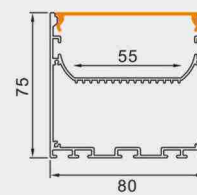

BG21

产品参数 **10075**

尺寸: Lx100x75mm
表面: 氧化铝本色/喷漆 (黑色/白色)
PC罩: 乳白
适用: 75MM软灯带/硬灯条

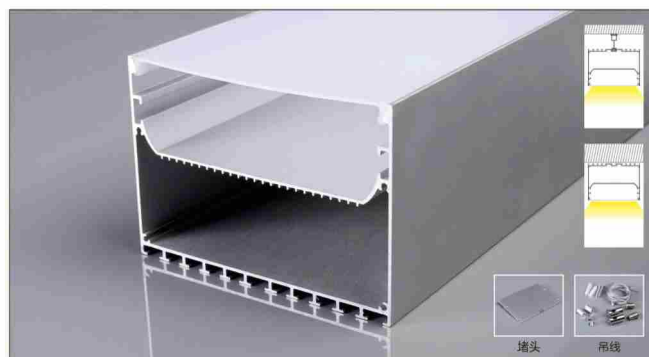
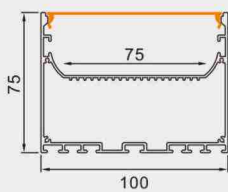

BG22

产品参数 **12085**

尺寸: Lx120x85mm
表面: 氧化铝本色/喷漆 (黑色/白色)
PC罩: 乳白
适用: 95MM软灯带/硬灯条

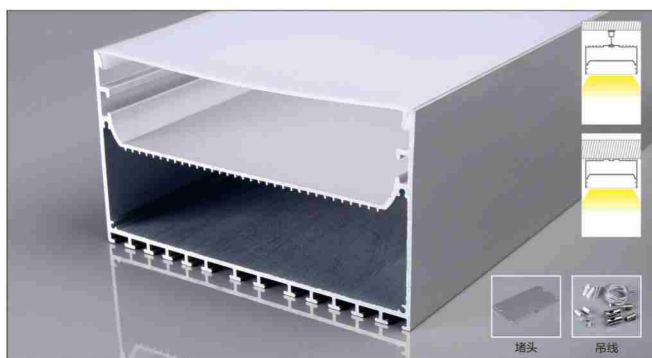
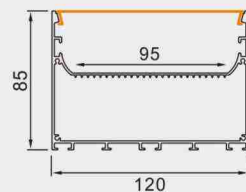

BG23

产品参数 **15085**

尺寸: Lx150x85mm
表面: 氧化铝本色/喷漆 (黑色/白色)
PC罩: 乳白
适用: 125MM软灯带/硬灯条

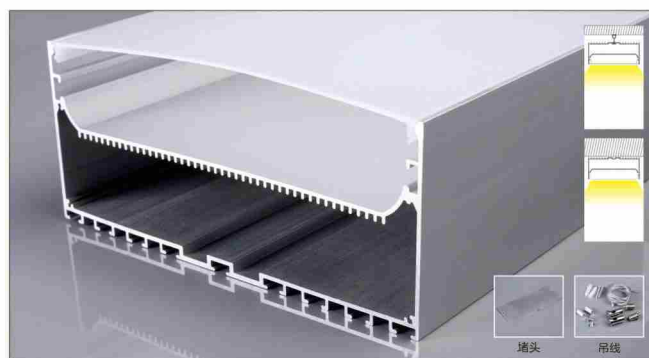
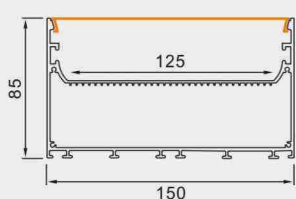

BG24

产品参数 **20085**

尺寸: Lx200x85mm
表面: 氧化铝本色/喷漆 (黑色/白色)
PC罩: 乳白
适用: 173MM软灯带/硬灯条

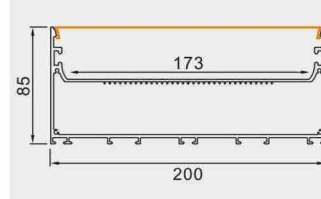

P31-P48

花边/氛围光

铝型材套件

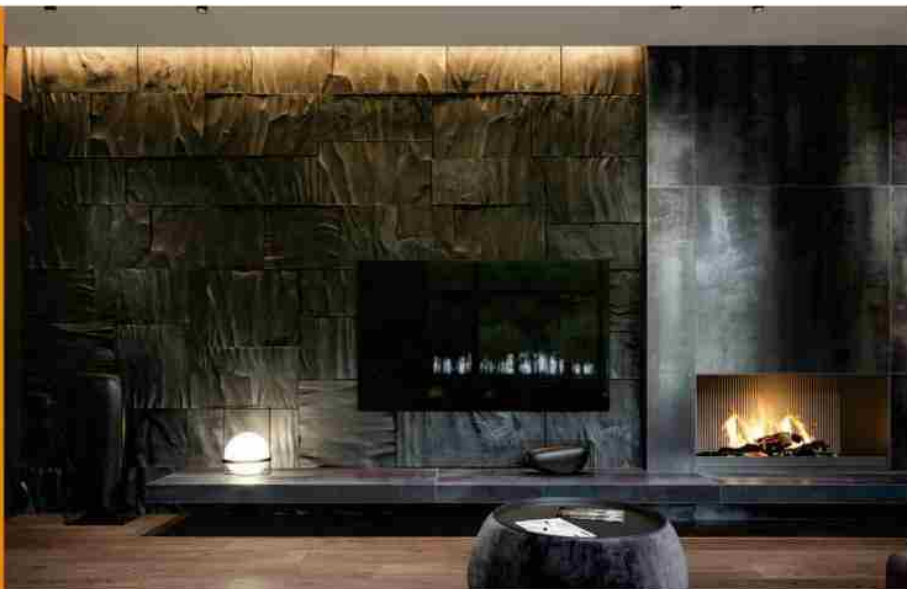

XT703

13侧花边

产品参数

尺寸: Lx33x12mm
表面: 氧化铝本色/喷漆 (黑色/白色/玫瑰金)
PC罩: 乳白/黑色/亚克力磨砂可选
适用: 10MM软灯带

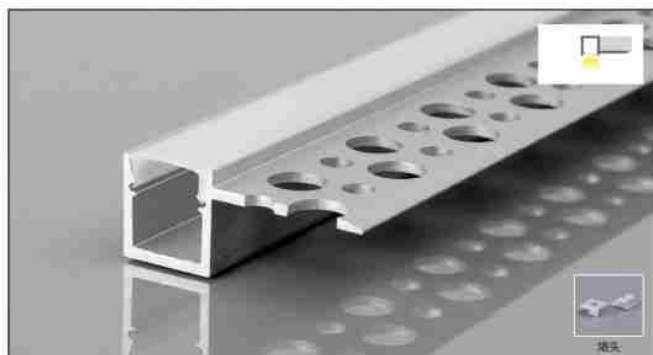
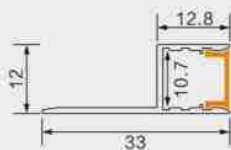

XT699

1313单上花边

产品参数

尺寸: Lx33x13mm
表面: 氧化铝本色/喷漆 (黑色/白色)
PC罩: 乳白/黑色/亚克力磨砂可选
适用: 10MM软灯带/硬灯条

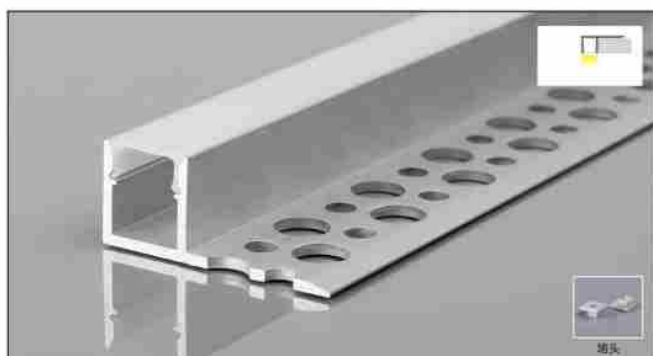
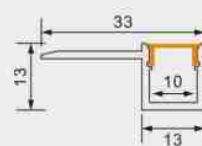

XT700

1313单下花边

产品参数

尺寸: Lx33x13mm
表面: 氧化铝本色/喷漆 (黑色/白色)
PC罩: 乳白/黑色/亚克力磨砂可选
适用: 10MM软灯带/硬灯条

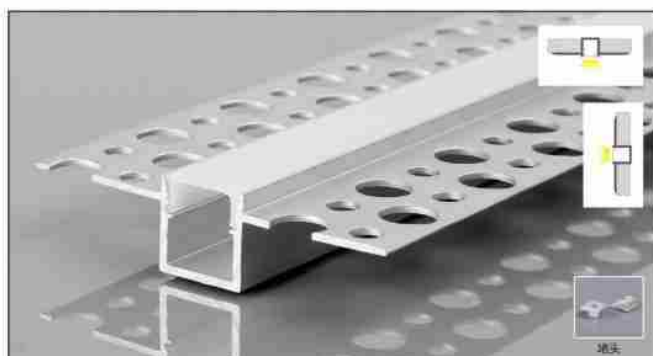
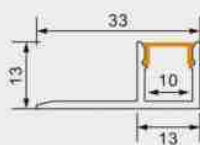

XT701

1313双上花边

产品参数

尺寸: Lx53x13mm
表面: 氧化铝本色/喷漆 (黑色/白色)
PC罩: 乳白/黑色/亚克力磨砂可选
适用: 10MM软灯带/硬灯条

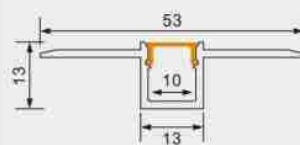

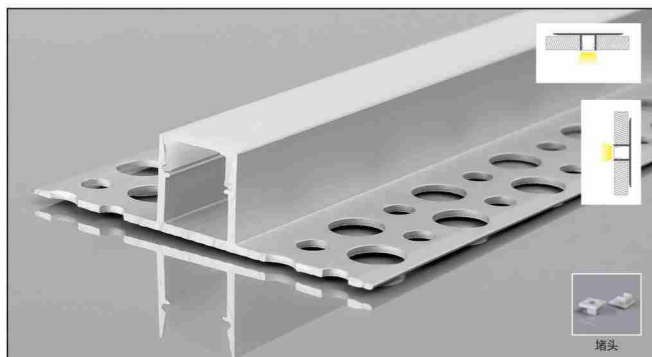

XT702

产品参数 **1313双下花边**

尺寸: Lx53x13mm
表面: 氧化铝本色/喷漆 (黑色/白色)
PC罩: 乳白/黑色/亚克力磨砂可选
适用: 10MM软灯带/硬灯条

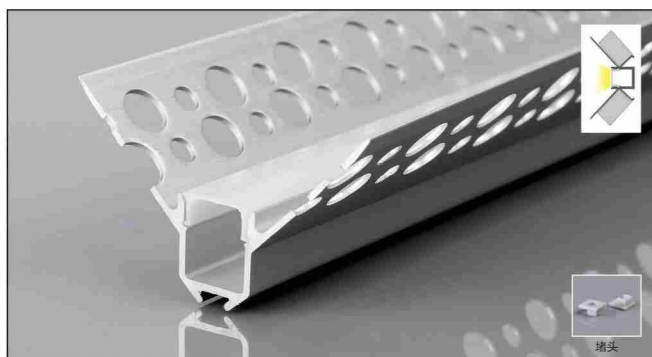
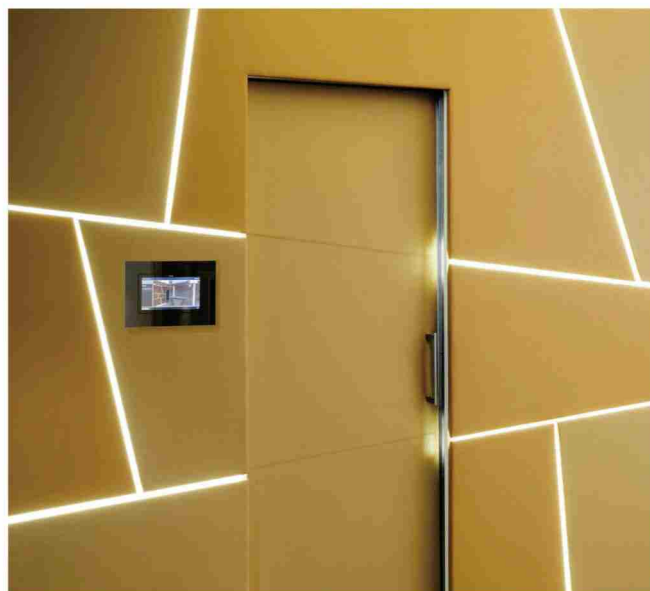
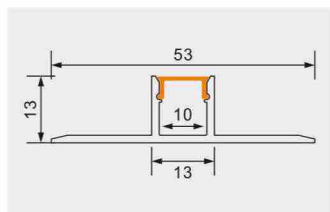

XT324

产品参数 **4824阴角花边**

尺寸: Lx48x24mm
表面: 氧化铝本色/喷漆 (黑色/白色)
PC罩: 乳白/黑色/亚克力磨砂可选
适用: 10MM软灯带/硬灯条

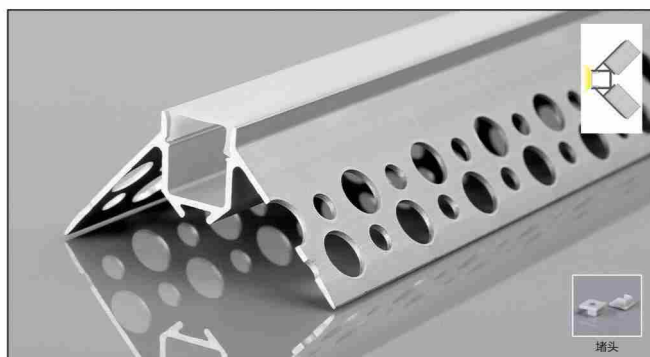
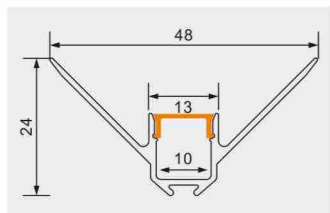

XT325

产品参数 **4521阳角花边**

尺寸: Lx45x20mm
表面: 氧化铝本色/喷漆 (黑色/白色)
PC罩: 乳白/黑色/亚克力磨砂可选
适用: 10MM软灯带/硬灯条

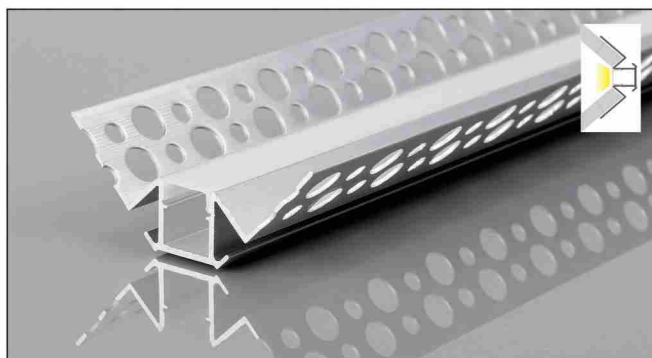
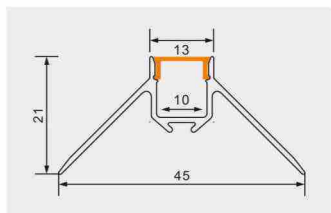

XT651

产品参数 **13瓷砖阴角**

尺寸: Lx54x28.4mm
表面: 氧化铝本色/喷漆 (黑色/白色/玫瑰金)
PC罩: 乳白/黑色/亚克力磨砂可选
适用: 10MM软灯带

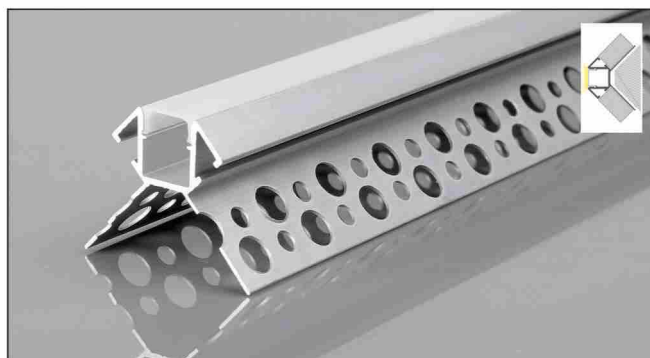
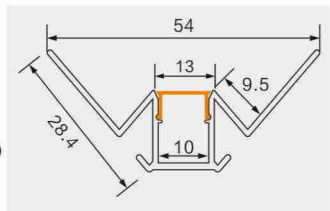

XT652

产品参数 **13瓷砖阳角**

尺寸: Lx41.3x30.3mm
表面: 氧化铝本色/喷漆 (黑色/白色/玫瑰金)
PC罩: 乳白/黑色/亚克力磨砂可选
适用: 10MM软灯带

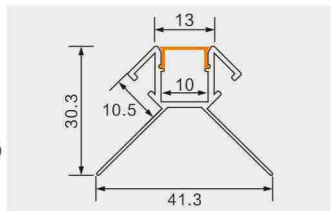

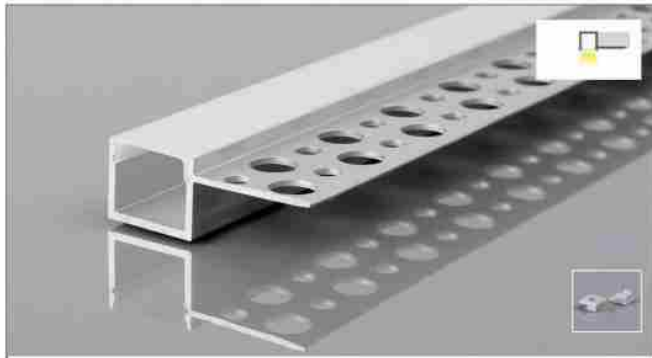

XT704

产品参数 **1513单上花边**

尺寸: Lx35x13mm
 表面: 氧化铝本色/喷漆 (黑色/白色)
 PC罩: 乳白/黑色/亚克力磨砂可选
 适用: 12MM软灯带/硬灯条

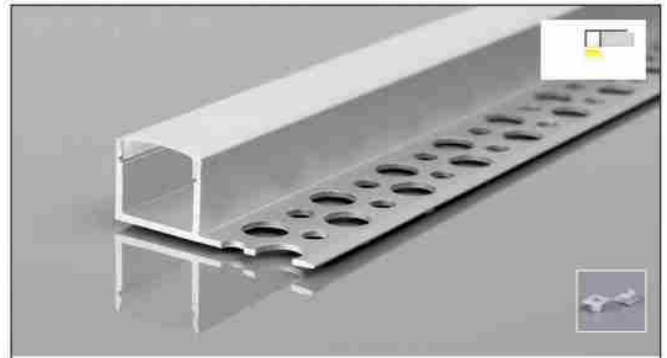
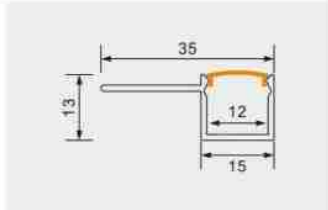

XT705

产品参数 **1513单下花边**

尺寸: Lx35x13mm
 表面: 氧化铝本色/喷漆 (黑色/白色)
 PC罩: 乳白/黑色/亚克力磨砂可选
 适用: 12MM软灯带/硬灯条

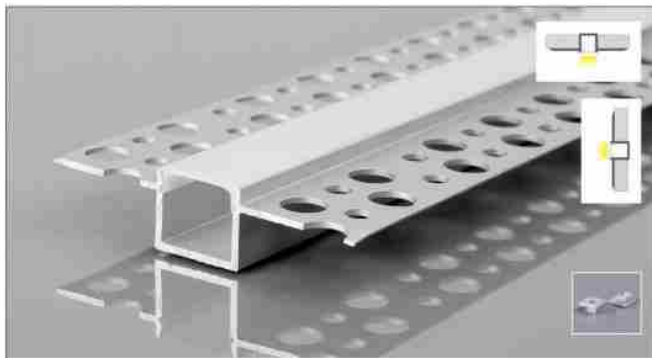
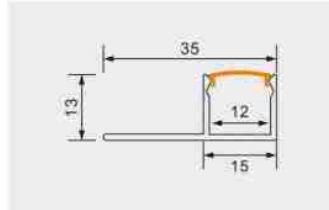

XT707

产品参数 **1513双上花边**

尺寸: Lx55x13mm
 表面: 氧化铝本色/喷漆 (黑色/白色)
 PC罩: 乳白/黑色/亚克力磨砂可选
 适用: 12MM软灯带/硬灯条

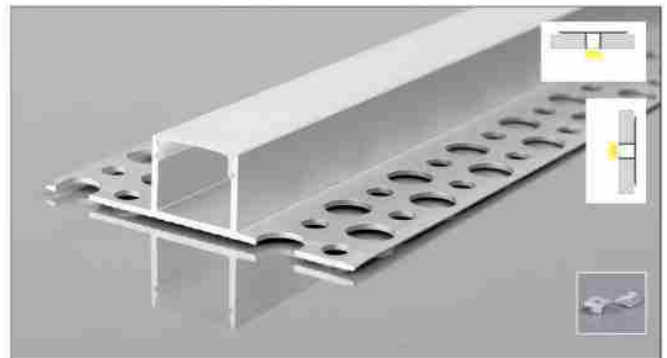
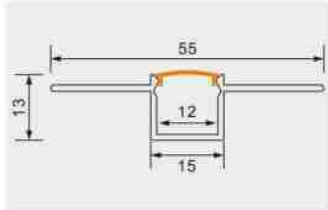

XT706

产品参数 **1513双下花边**

尺寸: Lx55x13mm
 表面: 氧化铝本色/喷漆 (黑色/白色)
 PC罩: 乳白/黑色/亚克力磨砂可选
 适用: 12MM软灯带/硬灯条

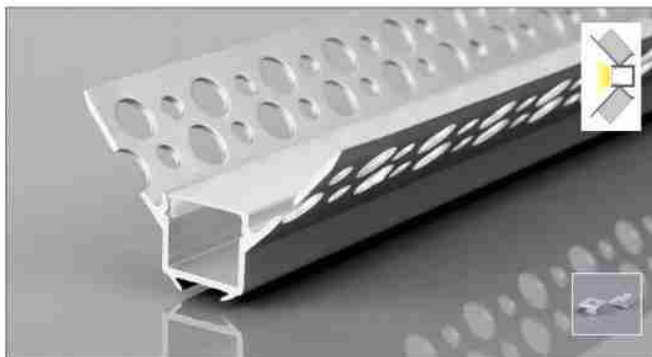
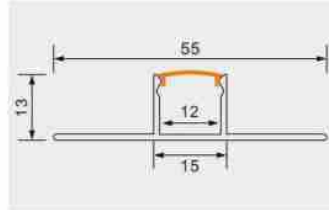

XT678

产品参数 **4726阴角花边**

尺寸: Lx47x26mm
 表面: 氧化铝本色/喷漆 (黑色/白色)
 PC罩: 乳白/黑色/亚克力磨砂可选
 适用: 10MM软灯带/硬灯条

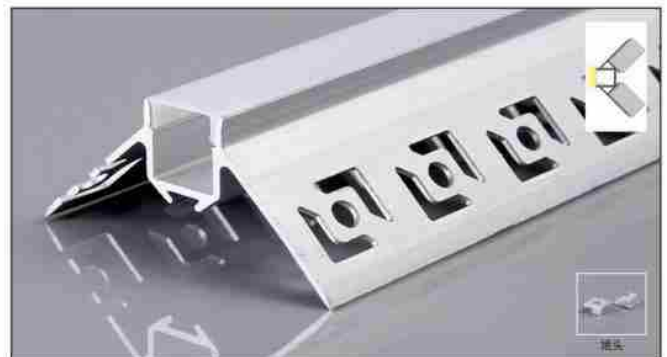
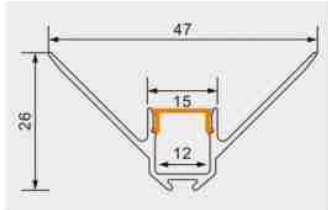

XT679

产品参数 **4723阳角花边**

尺寸: Lx47x23mm
 表面: 氧化铝本色/喷漆 (黑色/白色)
 PC罩: 乳白/黑色/亚克力磨砂可选
 适用: 10MM软灯带/硬灯条

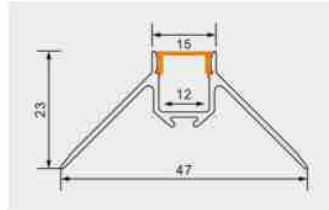

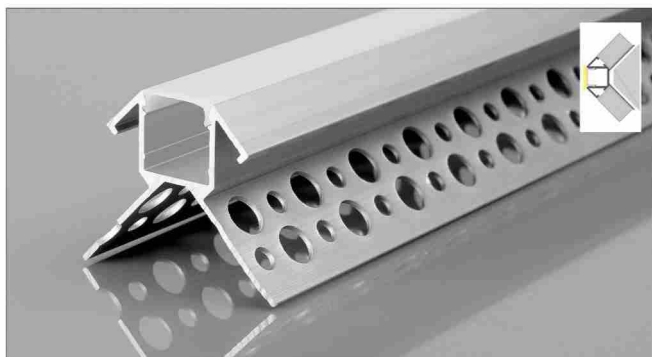

XT653

产品参数 15°瓷砖阳角

尺寸: Lx40.7x30.3mm
表面: 氧化铝本色/喷漆 (黑色/白色/玫瑰金)
PC罩: 乳白/黑色/亚克力磨砂可选
适用: 5MM软灯带

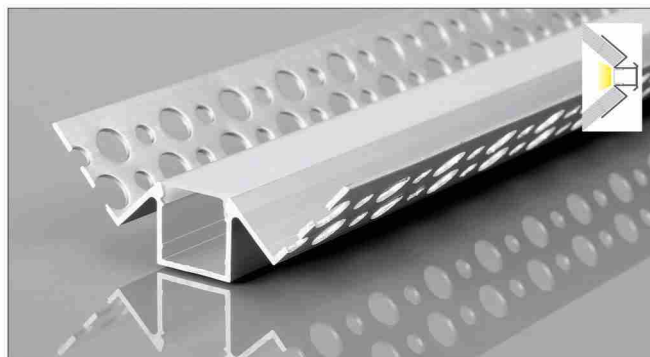
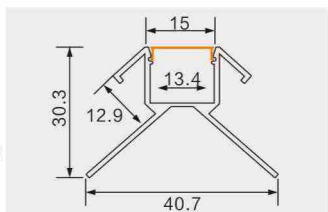

XT654

产品参数 15°瓷砖阴角

尺寸: Lx63.4x33mm
表面: 氧化铝本色/喷漆 (黑色/白色/玫瑰金)
PC罩: 乳白/黑色/亚克力磨砂可选
适用: 12MM软灯带

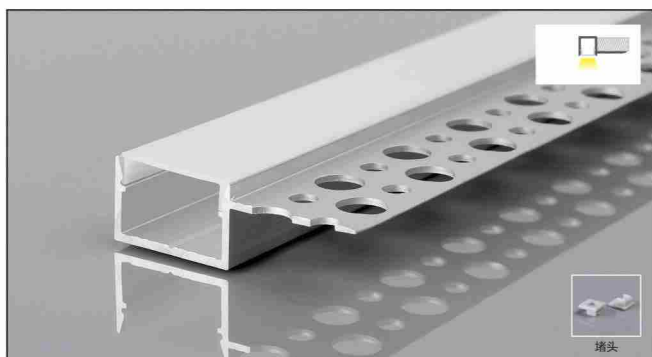
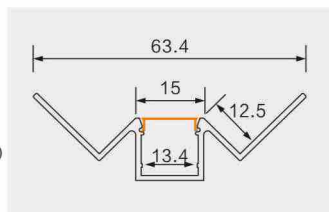

XT709

产品参数 2013单上花边

尺寸: Lx40x13mm
表面: 氧化铝本色/喷漆 (黑色/白色)
PC罩: 乳白/黑色/亚克力磨砂可选
适用: 17MM软灯带/硬灯条

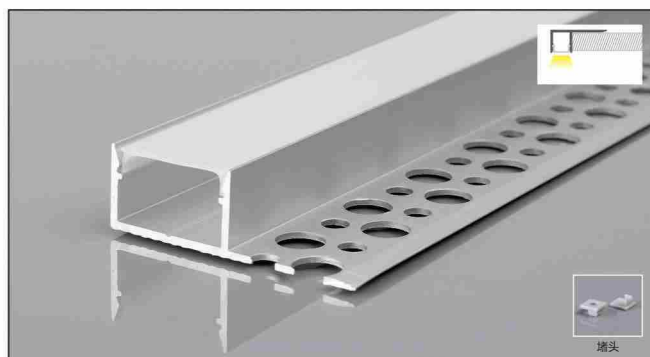
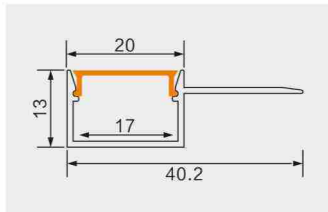

XT708

产品参数 2013单下花边

尺寸: Lx40x13mm
表面: 氧化铝本色/喷漆 (黑色/白色/玫瑰金)
PC罩: 乳白/黑色/亚克力磨砂可选
适用: 17MM软灯带

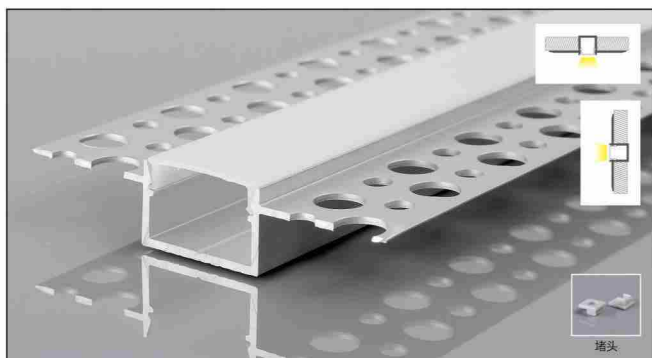
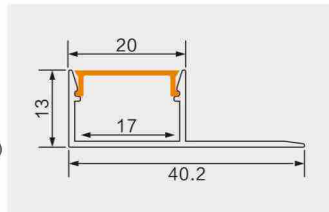

XT711

产品参数 2013双上花边

尺寸: Lx60x13mm
表面: 氧化铝本色/喷漆 (黑色/白色)
PC罩: 乳白/黑色/亚克力磨砂可选
适用: 17MM软灯带/硬灯条

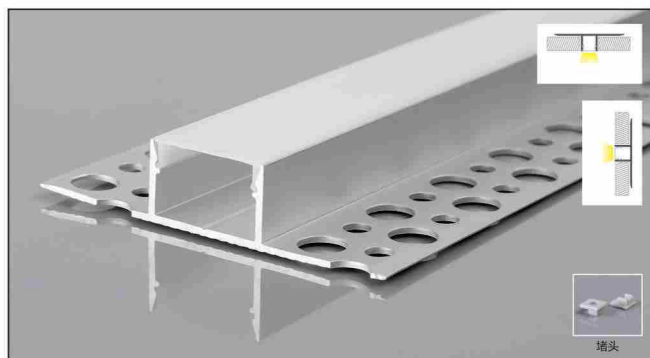
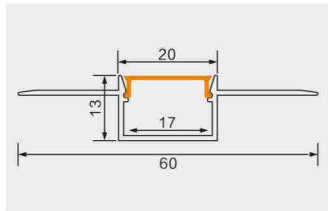

XT710

产品参数 2013双下花边

尺寸: Lx60x13mm
表面: 氧化铝本色/喷漆 (黑色/白色)
PC罩: 乳白/黑色/亚克力磨砂可选
适用: 17MM软灯带/硬灯条

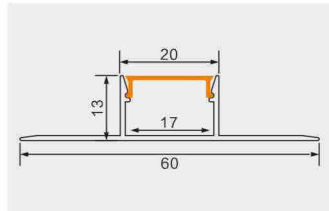

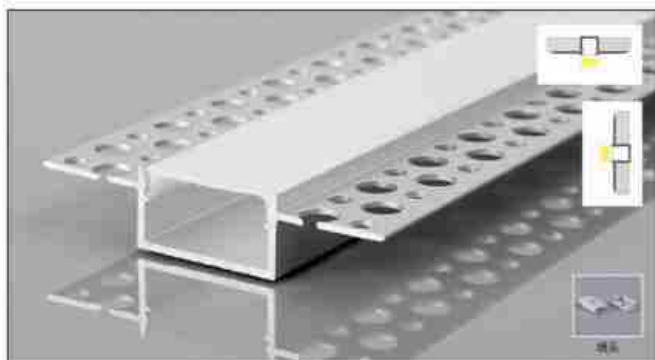

XT713

产品参数 **2313双上花边**

尺寸: Lx62x13mm
 表面: 氧化铝本色/喷漆 (黑色/白色)
 PC罩: 乳白/黑色/亚克力磨砂可选
 适用: 20MM软灯带/硬灯条

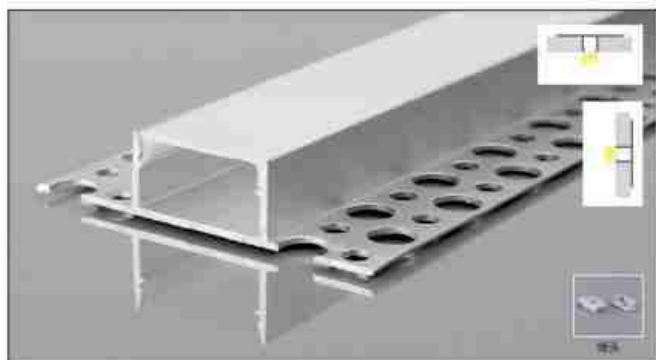
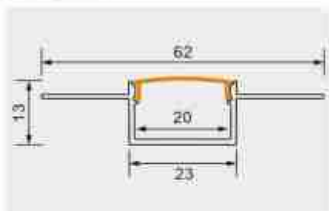

XT712

产品参数 **2313双下花边**

尺寸: Lx62x13mm
 表面: 氧化铝本色/喷漆 (黑色/白色)
 PC罩: 乳白/黑色/亚克力磨砂可选
 适用: 20MM软灯带/硬灯条

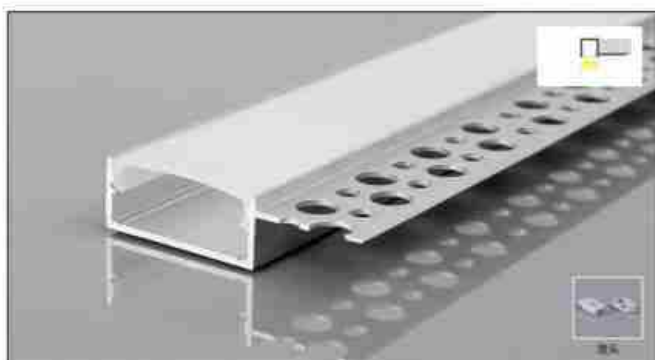
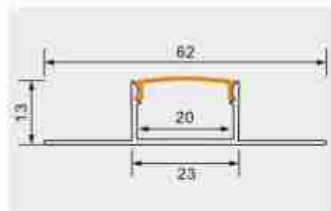

XT747

产品参数 **3013单上花边**

尺寸: Lx50x13mm
 表面: 氧化铝本色/喷漆 (黑色/白色)
 PC罩: 乳白/黑色/亚克力磨砂可选
 适用: 27MM软灯带/硬灯条

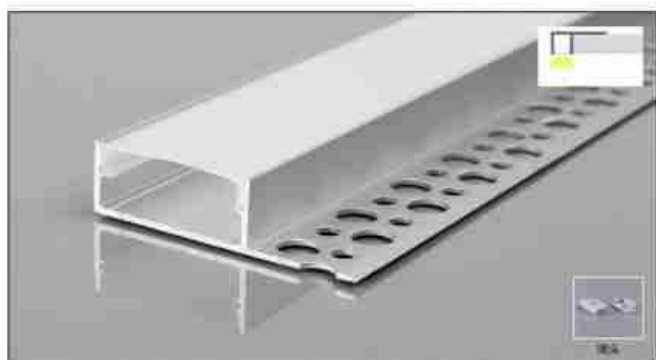
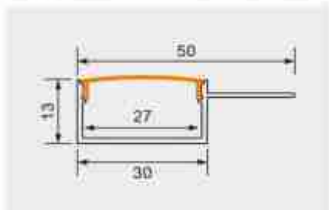

XT748

产品参数 **3013单下花边**

尺寸: Lx50x13mm
 表面: 氧化铝本色/喷漆 (黑色/白色/玫瑰金)
 PC罩: 乳白/黑色/亚克力磨砂可选
 适用: 27MM软灯带

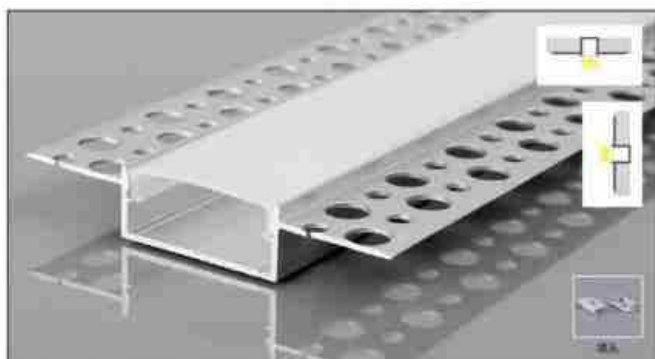
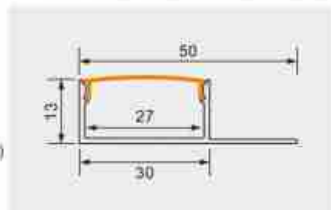

XT472

产品参数 **3013双上花边**

尺寸: Lx70x13mm
 表面: 氧化铝本色/喷漆 (黑色/白色)
 PC罩: 乳白/黑色/亚克力磨砂可选
 适用: 27MM软灯带/硬灯条

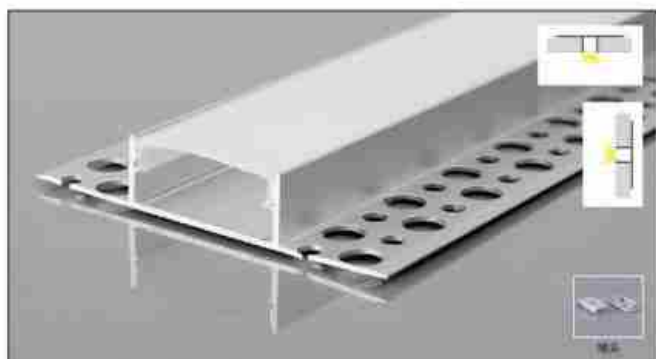
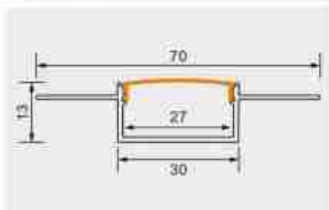

XT473

产品参数 **3013双下花边**

尺寸: Lx70x13mm
 表面: 氧化铝本色/喷漆 (黑色/白色)
 PC罩: 乳白/黑色/亚克力磨砂可选
 适用: 27MM软灯带/硬灯条

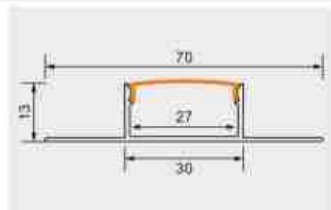

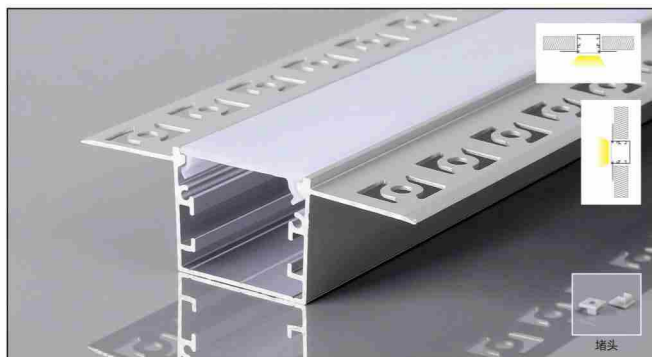

XT561

产品参数 **3025双花边上**

尺寸: Lx76x25mm
表面: 氧化铝本色/喷漆 (黑色/白色)
PC罩: 乳白/黑色/亚克力磨砂可选
适用: 28MM软灯带/硬灯条

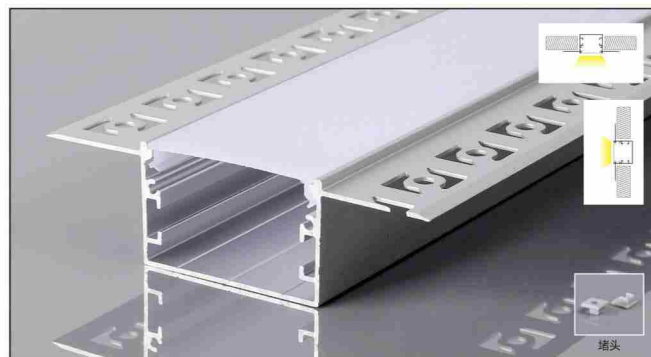
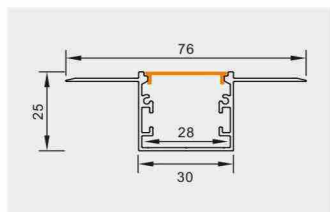

XT562

产品参数 **3525双花边上**

尺寸: Lx81x25mm
表面: 氧化铝本色/喷漆 (黑色/白色)
PC罩: 乳白/黑色/亚克力磨砂可选
适用: 33MM软灯带/硬灯条

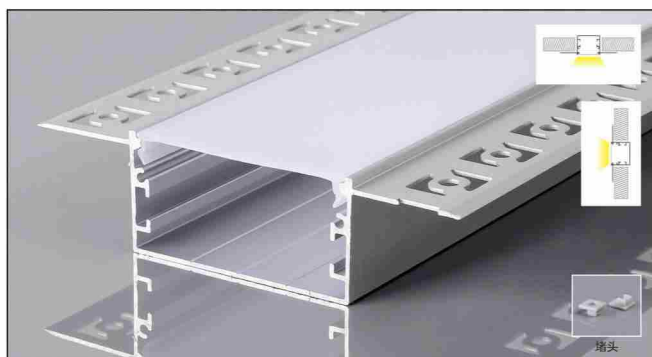
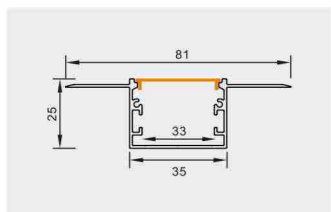

XT563

产品参数 **4025双花边上**

尺寸: Lx86x25mm
表面: 氧化铝本色/喷漆 (黑色/白色)
PC罩: 乳白/黑色/亚克力磨砂可选
适用: 38MM软灯带/硬灯条

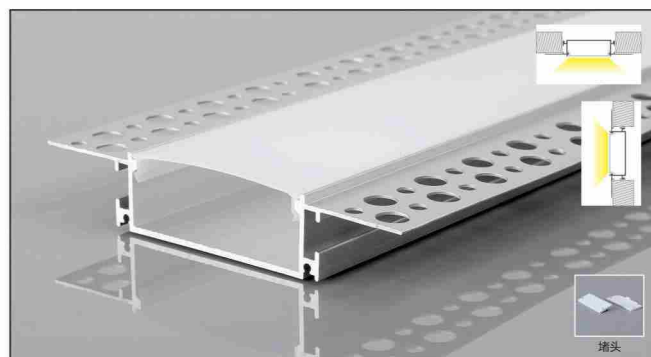
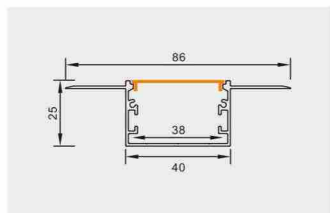

XT381

产品参数 **5720双花边上**

尺寸: Lx96.6x20mm
表面: 氧化铝本色/喷漆 (黑色/白色)
PC罩: 乳白/黑色/亚克力磨砂可选
适用: 46MM软灯带/硬灯条

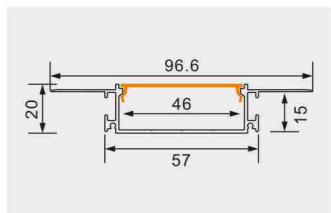

XT814

产品参数 **4710硅胶双上花边**

尺寸: Lx46.7x9.5mm
表面: 氧化铝本色/喷漆 (黑色/白色)
PC罩: 乳白/黑色/亚克力磨砂可选
适用: 5MM软灯带/硬灯条

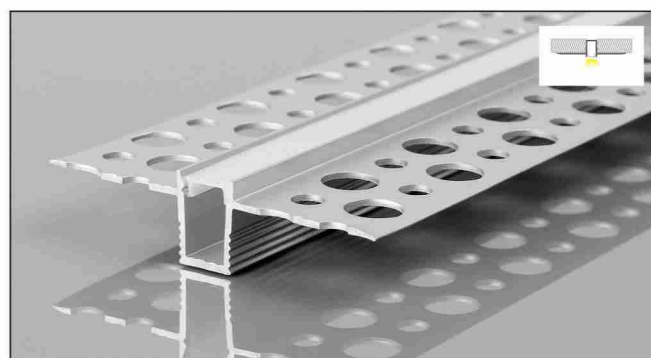
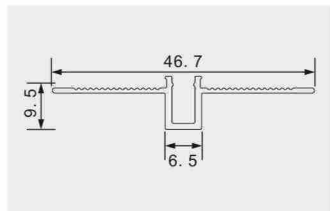

XT791

产品参数 **0812花边**

尺寸: Lx48x12mm
表面: 氧化铝本色/喷漆 (黑色/白色/玫瑰金)
PC罩: 乳白/黑色/亚克力磨砂可选
适用: 5MM软灯带

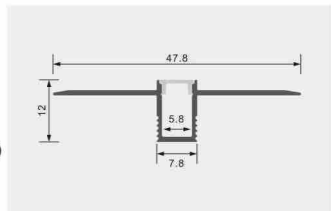

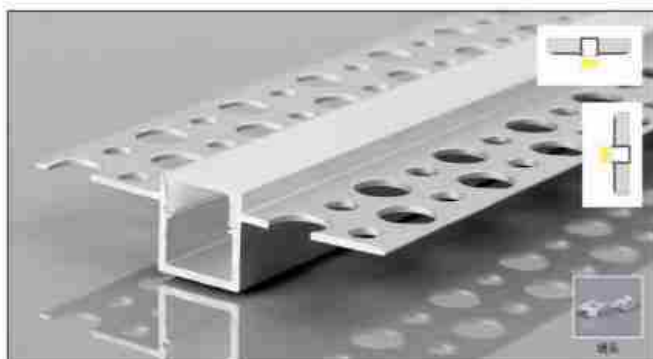

XT803

产品参数 **1013双上花边**

尺寸: Lx41x13mm
 表面: 氧化铝本色/喷漆 (黑色/白色)
 PC罩: 乳白/黑色/亚克力磨砂可选
 适用: 8MM软灯带/硬灯条

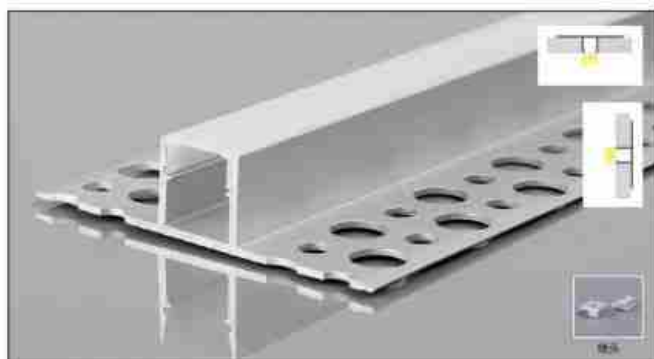
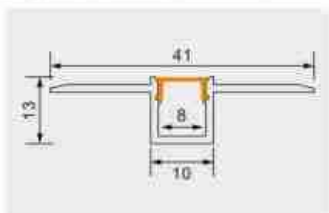

XT804

产品参数 **1013双下花边**

尺寸: Lx41x13mm
 表面: 氧化铝本色/喷漆 (黑色/白色)
 PC罩: 乳白/黑色/亚克力磨砂可选
 适用: 8MM软灯带/硬灯条

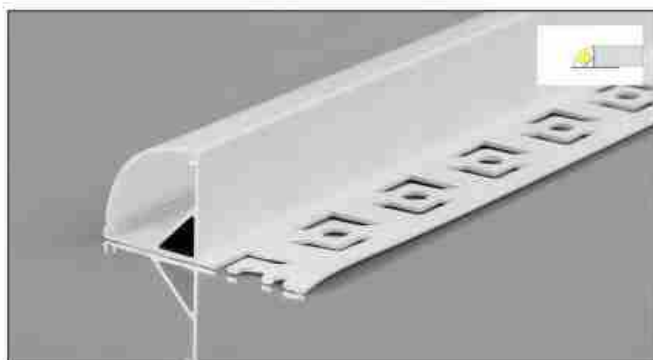
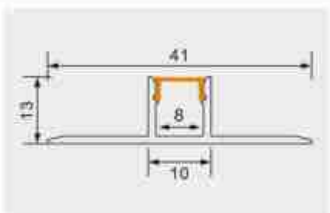

XT682

产品参数 **16三角花边**

尺寸: Lx33x15.9mm
 表面: 氧化铝本色/喷漆 (黑色/白色/玫瑰金)
 PC罩: 乳白/黑色/亚克力磨砂可选
 适用: 10MM软灯带

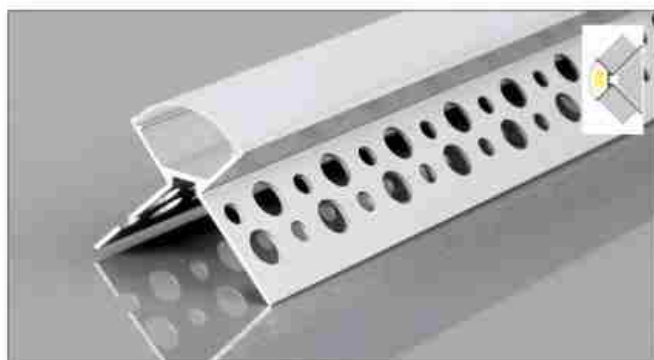
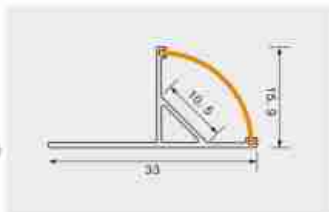

XT817

产品参数 **弧面瓷砖阳角**

尺寸: Lx36x36mm
 表面: 氧化铝本色/喷漆 (黑色/白色/玫瑰金)
 PC罩: 乳白/黑色/亚克力磨砂可选
 适用: 9MM软灯带

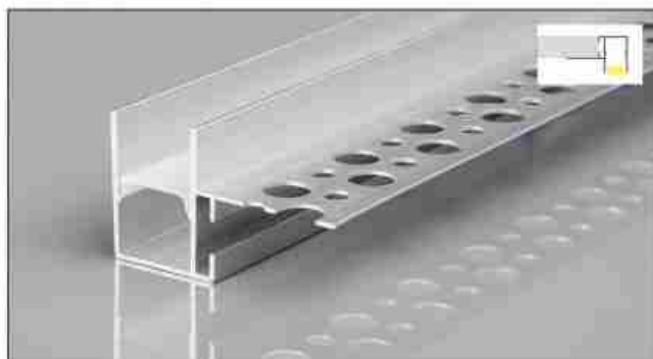

XT627

产品参数 **3823花边**

尺寸: Lx38x22.6mm
 表面: 氧化铝本色/喷漆 (黑色/白色/玫瑰金)
 PC罩: 乳白/黑色/亚克力磨砂可选
 适用: 12MM软灯带

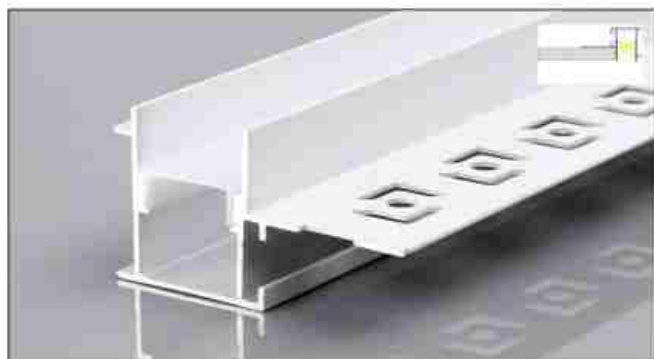
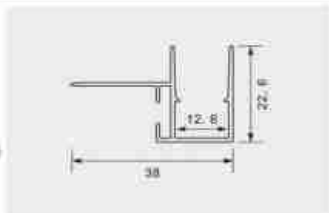

XT826

产品参数 **4223花边**

尺寸: Lx38x22.6mm
 表面: 氧化铝本色/喷漆 (黑色/白色/玫瑰金)
 PC罩: 乳白/黑色/亚克力磨砂可选
 适用: 12MM软灯带

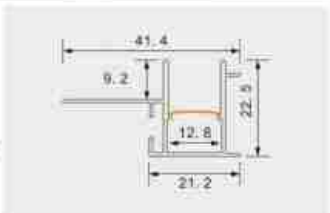

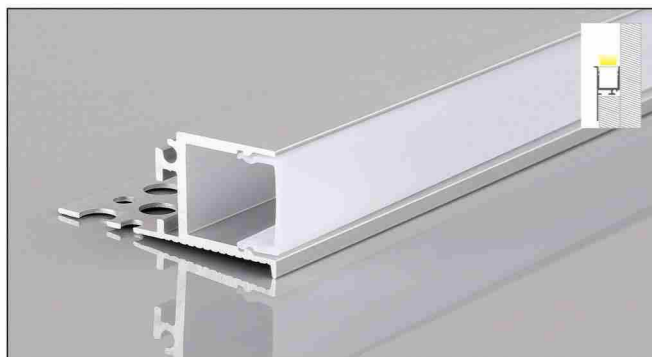

XT694

产品参数 **4319侧花边**

尺寸: Lx42.5x15.9mm
表面: 氧化铝本色/喷漆 (黑色/白色/玫瑰金)
PC罩: 乳白/黑色/亚克力磨砂可选
适用: 14MM软灯带

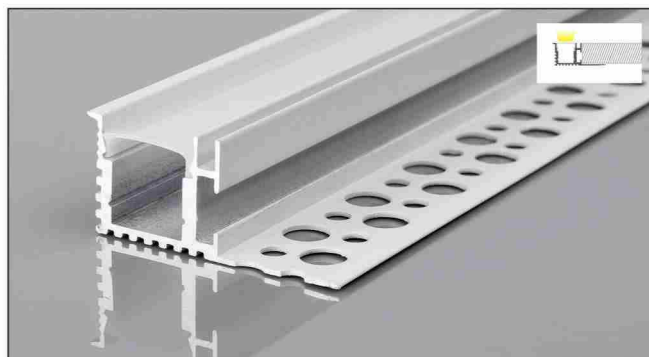
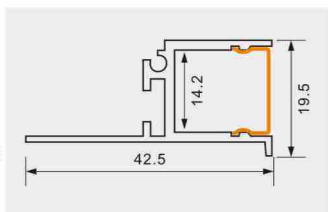

XT628

产品参数 **4319花边**

尺寸: Lx43.5x18.5mm
表面: 氧化铝本色/喷漆 (黑色/白色/玫瑰金)
PC罩: 乳白/黑色/亚克力磨砂可选
适用: 12MM软灯带

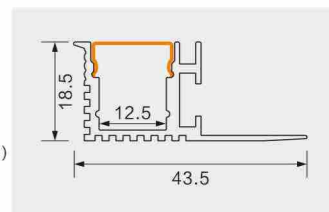

XT630

产品参数 **4152批灰**

尺寸: Lx40.7x51.5mm
表面: 氧化铝本色/喷漆 (黑色/白色/玫瑰金)
PC罩: 乳白/黑色/亚克力磨砂可选
适用: 14MM软灯带

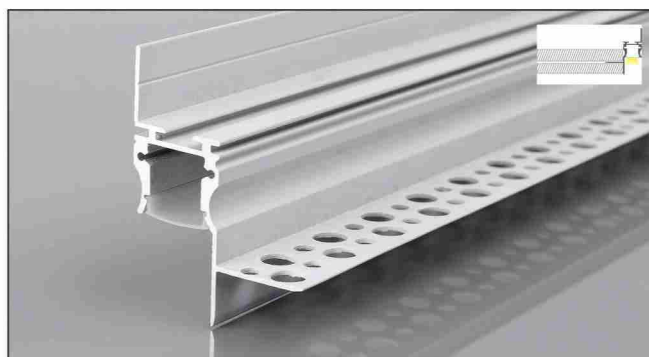
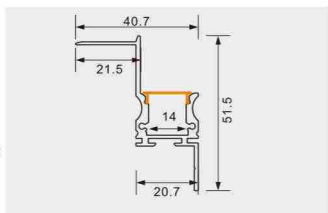

XT800

产品参数 **4152夹板**

尺寸: Lx40.7x51.5mm
表面: 氧化铝本色/喷漆 (黑色/白色/玫瑰金)
PC罩: 乳白/黑色/亚克力磨砂可选
适用: 14MM软灯带

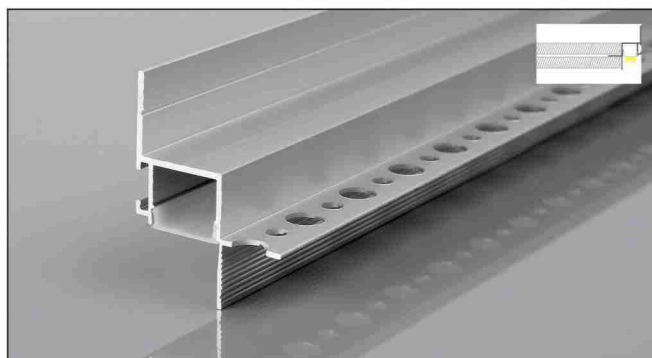
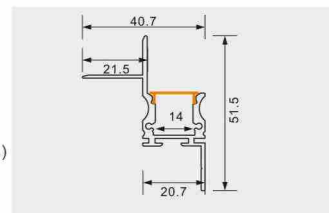

XT685

产品参数 **3040花边**

尺寸: Lx30.4x40mm
表面: 氧化铝本色/喷漆 (黑色/白色/玫瑰金)
PC罩: 乳白/黑色/亚克力磨砂可选
适用: 12MM软灯带

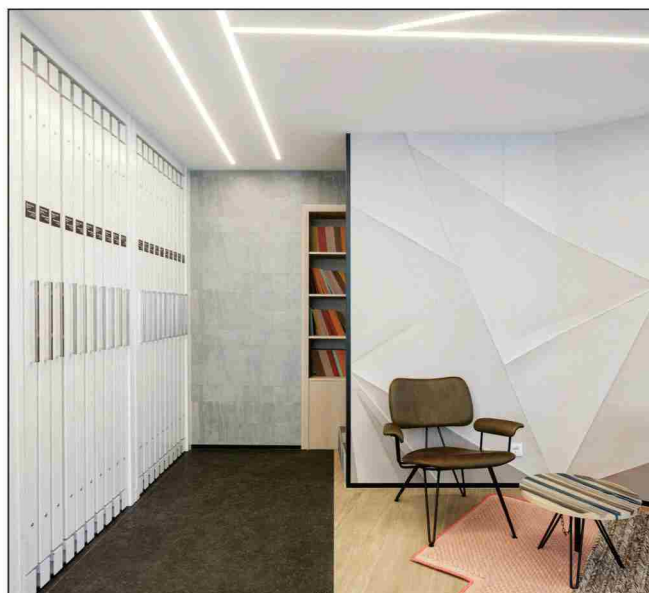
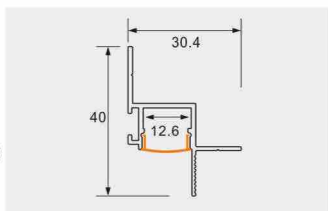

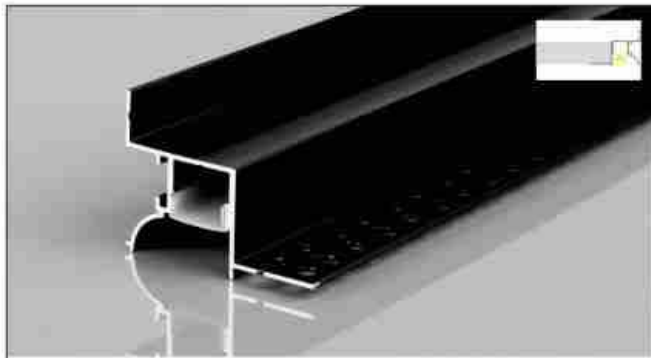

XT825

产品参数 **4533回光批灰**

尺寸: Lx40.745.4x33mm
 表面: 氧化铝本色/喷漆 (黑色/白色/玫瑰金)
 PC罩: 乳白/黑色/亚克力磨砂可选
 适用: 12MM软灯带

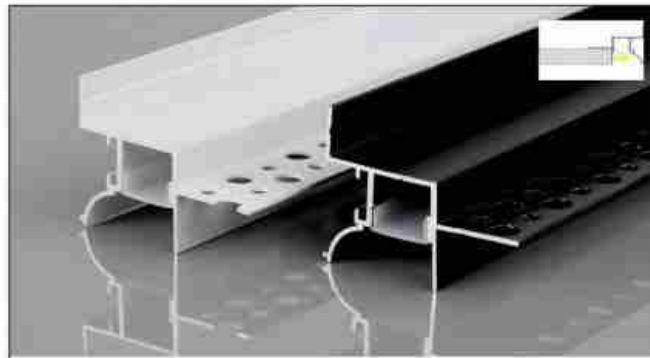
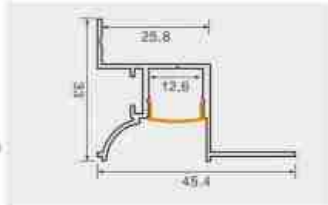

XT680

产品参数 **4533回光**

尺寸: Lx45.4x33mm
 表面: 氧化铝本色/喷漆 (黑色/白色/玫瑰金)
 PC罩: 乳白/黑色/亚克力磨砂可选
 适用: 12MM软灯带

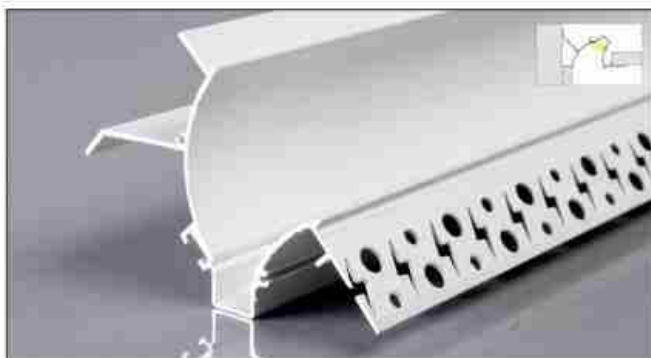
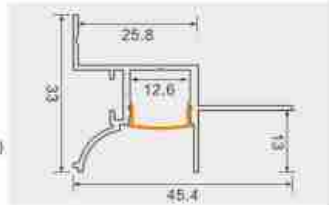

XT480

产品参数 **8050洗墙灯**

尺寸: Lx90x50mm
 表面: 氧化铝本色/喷漆 (黑色/白色)
 PC罩: 乳白/黑色/亚克力磨砂可选
 适用: 10MM软灯带/硬灯条

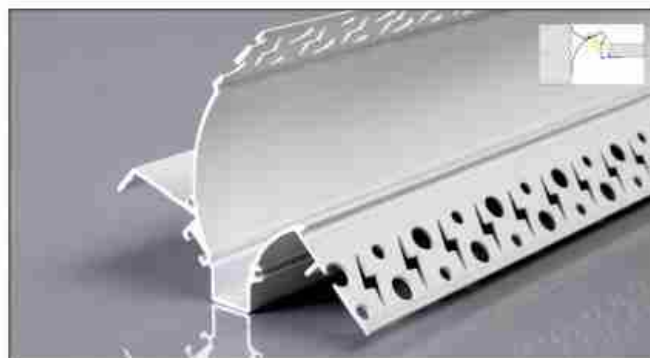
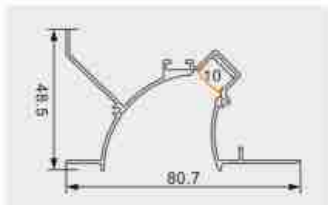

XT566

产品参数 **7068洗墙灯**

尺寸: Lx70x68mm
 表面: 氧化铝本色/喷漆 (黑色/白色)
 PC罩: 乳白/黑色/亚克力磨砂可选
 适用: 10MM软灯带/硬灯条

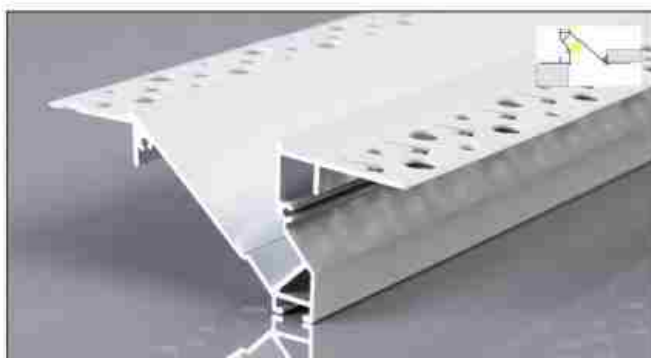

XT485

产品参数 **9235洗墙灯**

尺寸: Lx92x35mm
 表面: 氧化铝本色/喷漆 (黑色/白色)
 PC罩: 乳白/黑色/亚克力磨砂可选
 适用: 10MM软灯带/硬灯条

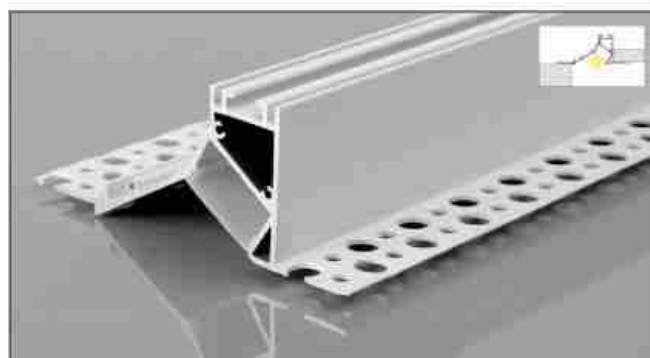
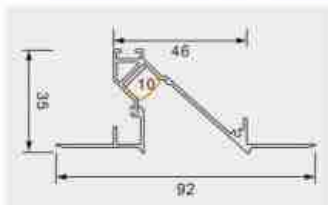

XT486

产品参数 **9538洗墙灯**

尺寸: Lx95x38mm
 表面: 氧化铝本色/喷漆 (黑色/白色)
 PC罩: 乳白/黑色/亚克力磨砂可选
 适用: 15MM软灯带/硬灯条

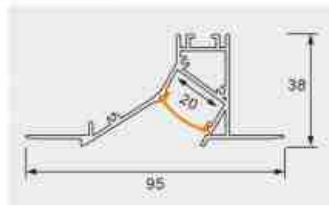

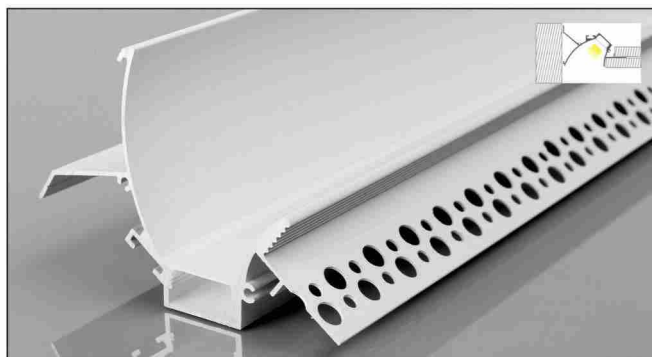

XT573

产品参数 **9059回光槽夹板**

尺寸: Lx90x579mm
表面: 氧化铝本色/喷漆 (黑色/白色)
PC罩: 乳白/黑色/亚克力磨砂可选
适用: 20MM软灯带/硬灯条

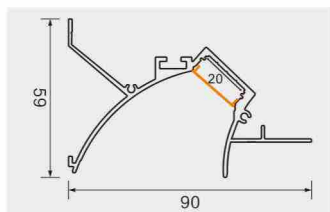

XT822

产品参数 **9881洗墙灯**

尺寸: Lx98x81mm
表面: 氧化铝本色/喷漆 (黑色/白色)
PC罩: 乳白/黑色/亚克力磨砂可选
适用: 20MM软灯带/硬灯条

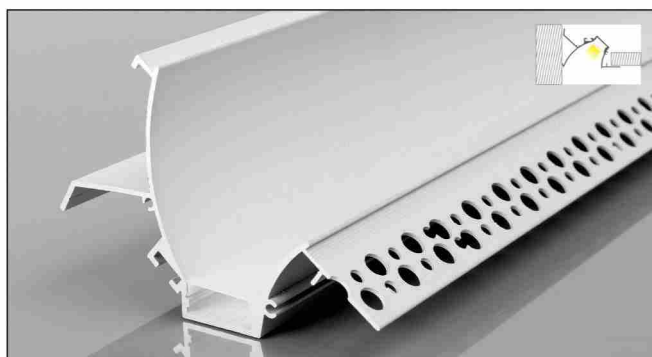
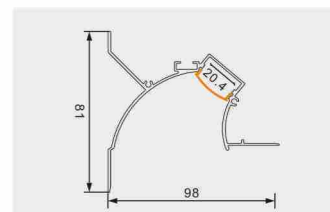

XT693

产品参数 **8657回光槽批灰**

尺寸: Lx85.6x57mm
表面: 氧化铝本色/喷漆 (黑色/白色)
PC罩: 乳白/黑色/亚克力磨砂可选
适用: 20MM软灯带/硬灯条

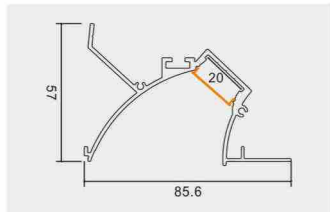

XT830

产品参数 **7564回光**

尺寸: Lx75.8x63mm
表面: 氧化铝本色/喷漆 (黑色/白色/玫瑰金)
PC罩: 乳白/黑色/亚克力磨砂可选
适用: 15MM软灯带

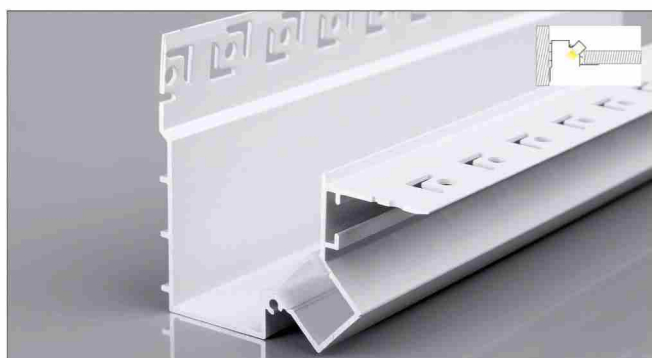
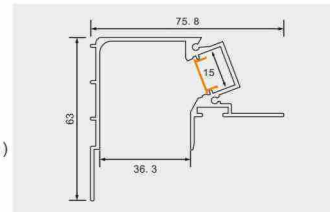

XT831

产品参数 **7564回光**

尺寸: Lx75.8x63mm
表面: 氧化铝本色/喷漆 (黑色/白色/玫瑰金)
PC罩: 乳白/黑色/亚克力磨砂可选
适用: 15MM软灯带

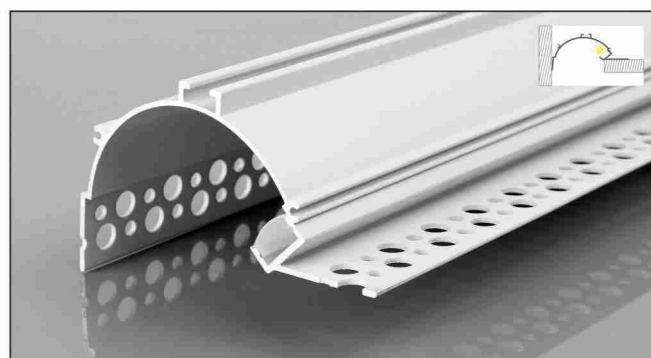
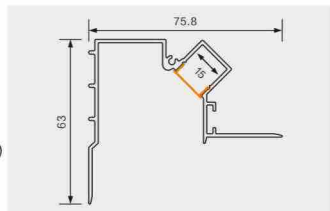

XT525

产品参数 **9150回光槽**

尺寸: Lx91x50mm
表面: 氧化铝本色/喷漆 (黑色/白色)
PC罩: 乳白/黑色/亚克力磨砂可选
适用: 12MM软灯带/硬灯条

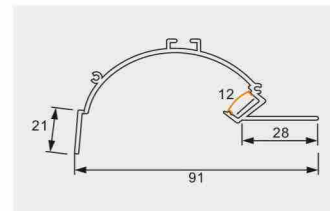

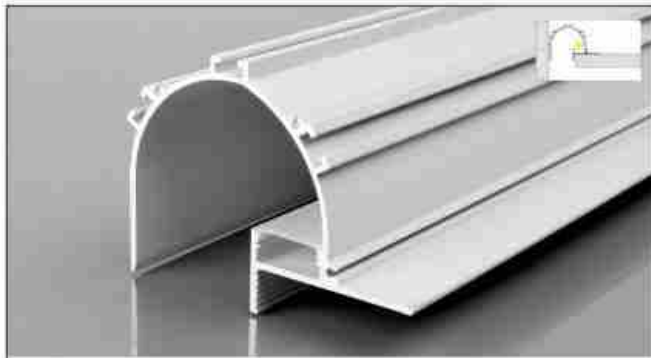

XT674

产品参数 **9570回光**

尺寸: Lx95x70mm
 表面: 氧化铝本色/喷漆 (黑色/白色/玫瑰金)
 PC罩: 乳白/黑色/亚克力磨砂可选
 适用: 20MM软灯带

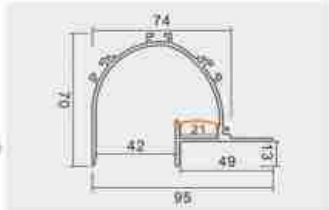

XT787

产品参数 **9935回光**

尺寸: Lx90x34.5mm
 表面: 氧化铝本色/喷漆 (黑色/白色/玫瑰金)
 PC罩: 乳白/黑色/亚克力磨砂可选
 适用: 12MM软灯带

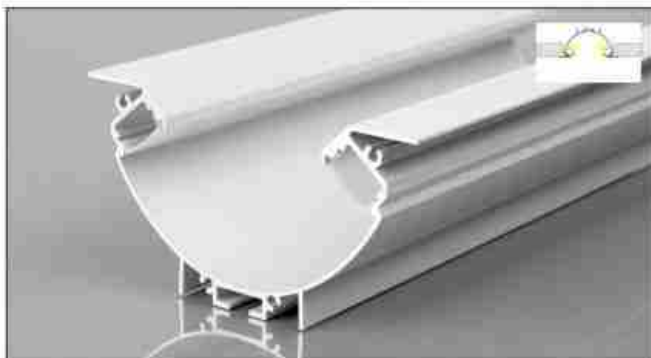
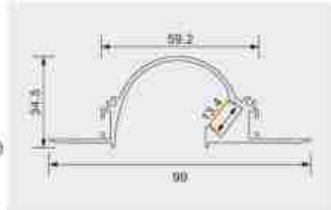

BG98

产品参数 **10050回光槽**

尺寸: Lx100x50mm
 表面: 氧化铝本色/喷漆 (黑色/白色)
 PC罩: 乳白/黑色/亚克力磨砂可选
 适用: 12MM软灯带/硬灯条

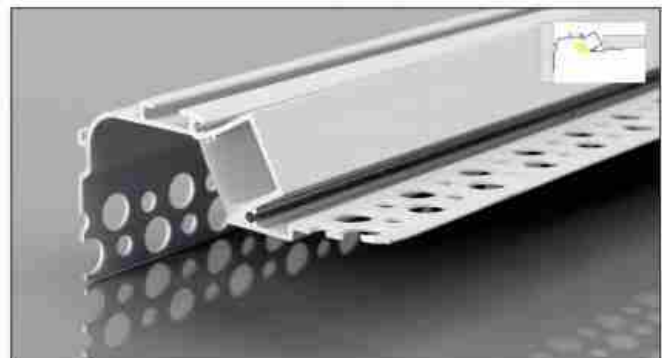
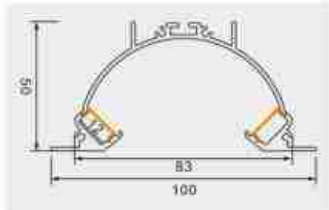

XT786

产品参数 **7040回光**

尺寸: Lx70x10.2mm
 表面: 氧化铝本色/喷漆 (黑色/白色/玫瑰金)
 PC罩: 乳白/黑色/亚克力磨砂可选
 适用: 12MM软灯带

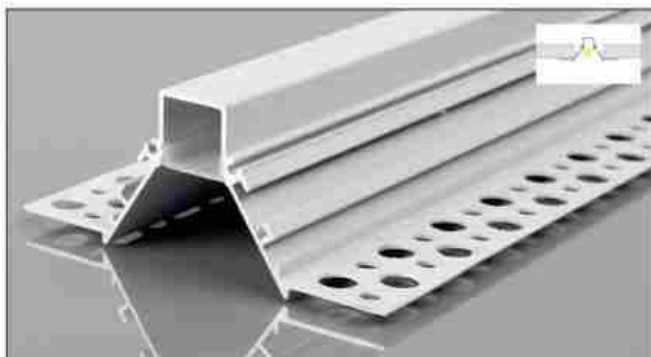
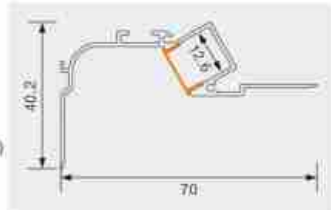

XT789

产品参数 **8132回光**

尺寸: Lx81.4x32mm
 表面: 氧化铝本色/喷漆 (黑色/白色/玫瑰金)
 PC罩: 乳白/黑色/亚克力磨砂可选
 适用: 12MM软灯带

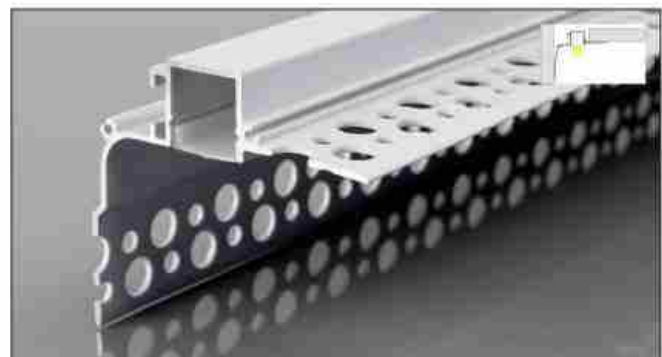
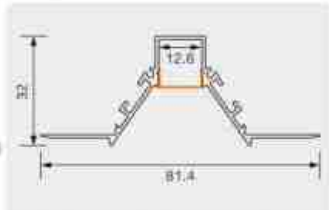

XT788

产品参数 **5550回光**

尺寸: Lx55x50mm
 表面: 氧化铝本色/喷漆 (黑色/白色/玫瑰金)
 PC罩: 乳白/黑色/亚克力磨砂可选
 适用: 12MM软灯带

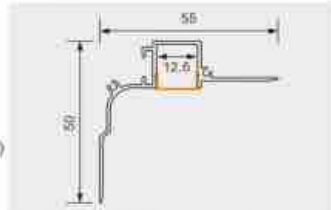

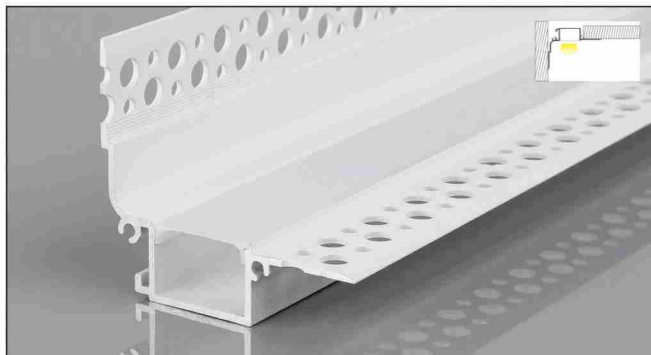

XT824

产品参数 **5851回光**

尺寸: Lx58.2x51mm
表面: 氧化铝本色/喷漆 (黑色/白色/玫瑰金)
PC罩: 乳白/黑色/亚克力磨砂可选
适用: 21MM软灯带

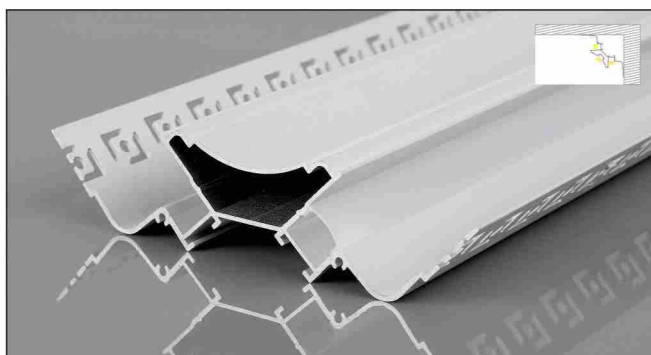
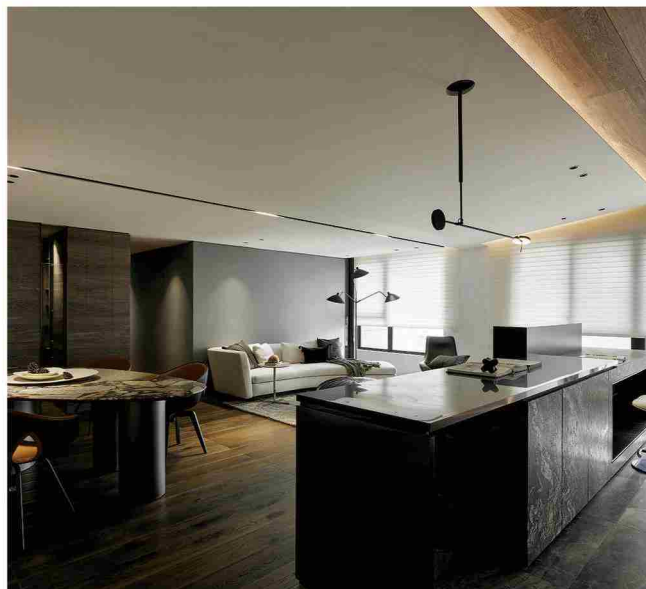
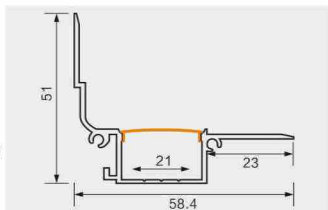

XT837

产品参数 **9595顶角线**

尺寸: Lx94x94mm
表面: 氧化铝本色/喷漆 (黑色/白色/玫瑰金)
PC罩: 乳白/黑色/亚克力磨砂可选
适用: 12MM软灯带

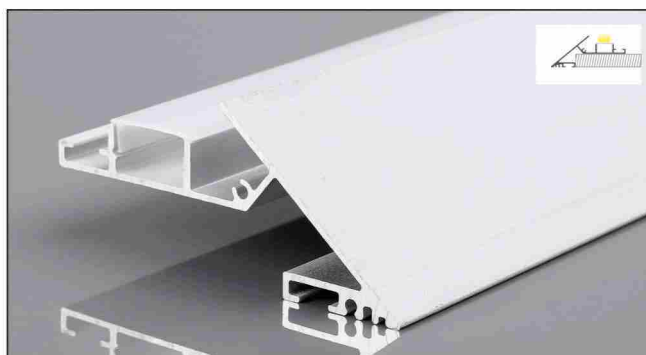
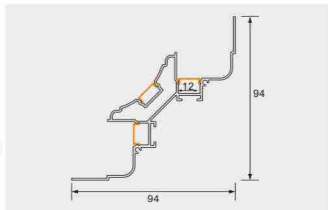

XT808

产品参数 **6126天花斜边**

尺寸: Lx61x25.7mm
表面: 氧化铝本色/喷漆 (黑色/白色/玫瑰金)
PC罩: 乳白/黑色/亚克力磨砂可选
适用: 12MM软灯带

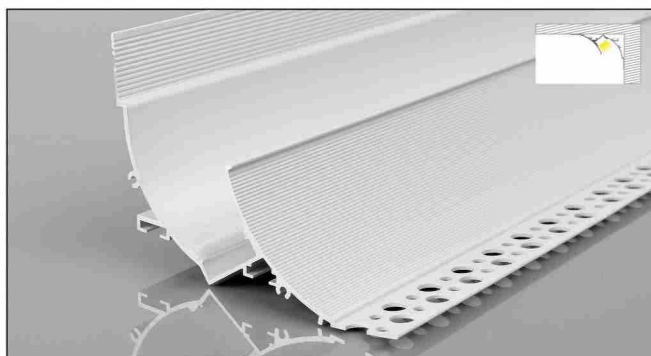
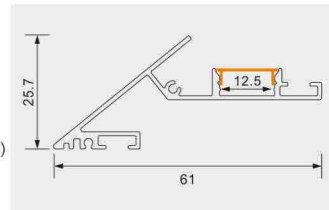

XT801

产品参数 **9675一体**

尺寸: Lx96x75mm
表面: 氧化铝本色/喷漆 (黑色/白色/玫瑰金)
PC罩: 乳白/黑色/亚克力磨砂可选
适用: 20MM软灯带

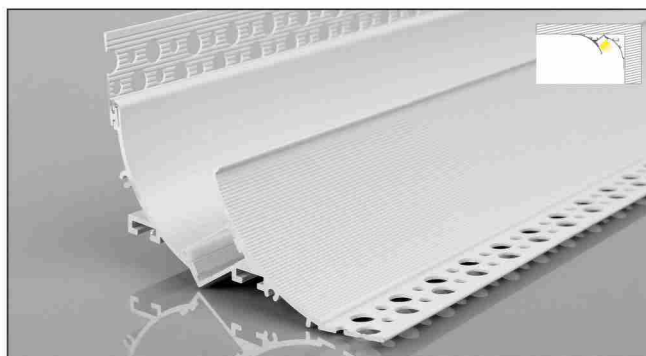
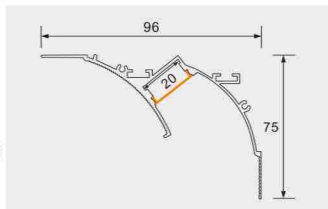

XT724+725

产品参数 **9675分体**

尺寸: Lx96x75mm
表面: 氧化铝本色/喷漆 (黑色/白色/玫瑰金)
PC罩: 乳白/黑色/亚克力磨砂可选
适用: 20MM软灯带

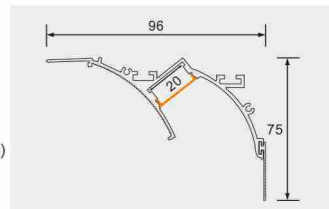

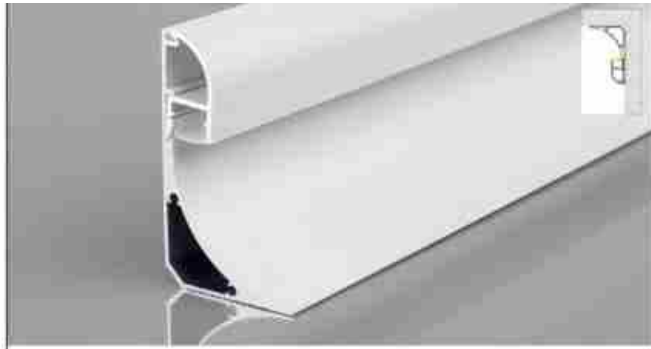

XT691+828

产品参数 **3760顶角线**

尺寸: Lx36.5x90mm
 表面: 氧化铝本色/喷漆 (黑色/白色/玫瑰金)
 PC罩: 乳白/黑色/亚克力磨砂可选
 适用: 10MM软灯带

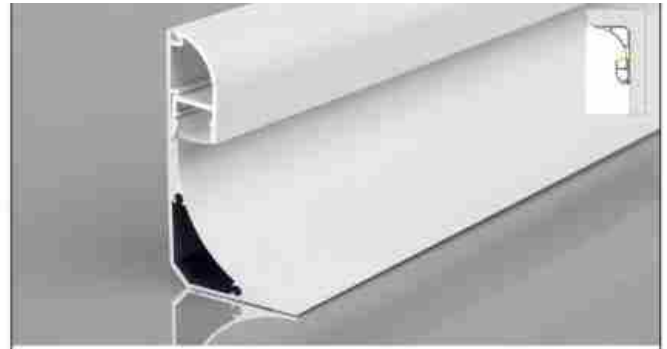

XT691+829

产品参数 **3780顶角线**

尺寸: Lx36.5x80mm
 表面: 氧化铝本色/喷漆 (黑色/白色/玫瑰金)
 PC罩: 乳白/黑色/亚克力磨砂可选
 适用: 10MM软灯带

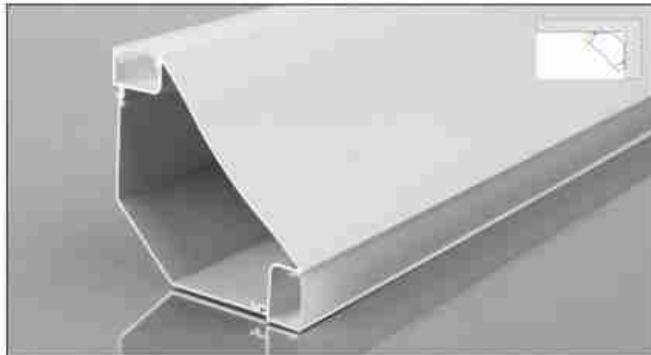
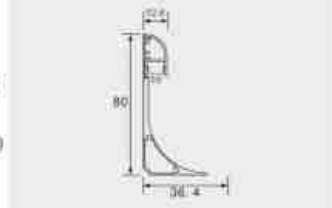

XT714+715

产品参数 **6868顶角线**

尺寸: Lx68x68mm
 表面: 氧化铝本色/喷漆 (黑色/白色/玫瑰金)
 PC罩: 乳白/黑色/亚克力磨砂可选
 适用: 15MM软灯带

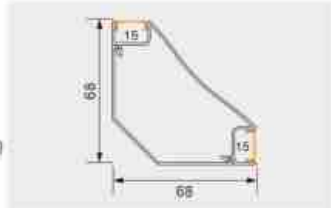

XT823

产品参数 **5961顶角线**

尺寸: Lx58.2x51mm
 表面: 氧化铝本色/喷漆 (黑色/白色/玫瑰金)
 PC罩: 乳白/黑色/亚克力磨砂可选
 适用: 21MM软灯带

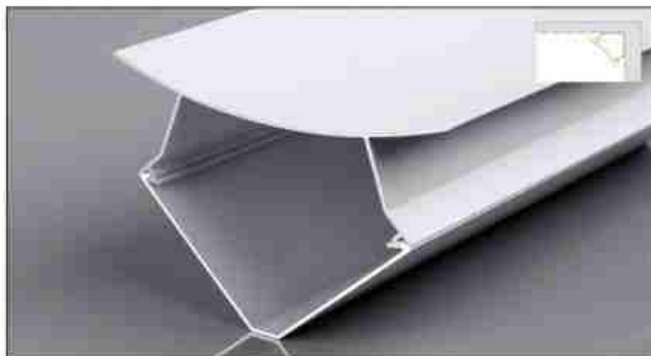
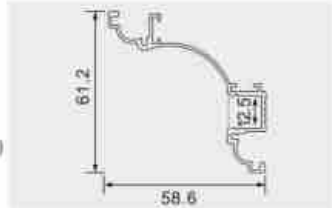

XT832+714

产品参数 **8585角线**

尺寸: Lx85x85mm
 表面: 氧化铝本色/喷漆 (黑色/白色/玫瑰金)
 PC罩: 乳白/黑色/亚克力磨砂可选
 适用: 18MM软灯带



XT835+836

产品参数 **5959顶角线**

尺寸: Lx81.4x32mm
 表面: 氧化铝本色/喷漆 (黑色/白色/玫瑰金)
 PC罩: 乳白/黑色/亚克力磨砂可选
 适用: 10MM软灯带

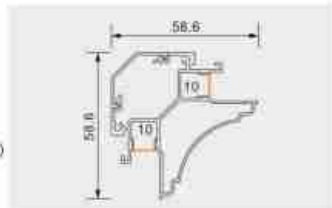



XT833+834+714

产品参数 **7272顶角线**

尺寸: Lx72x72mm
表面: 氧化铝本色/喷漆 (黑色/白色/玫瑰金)
PC罩: 乳白/黑色/亚克力磨砂可选
适用: 12MM软灯带

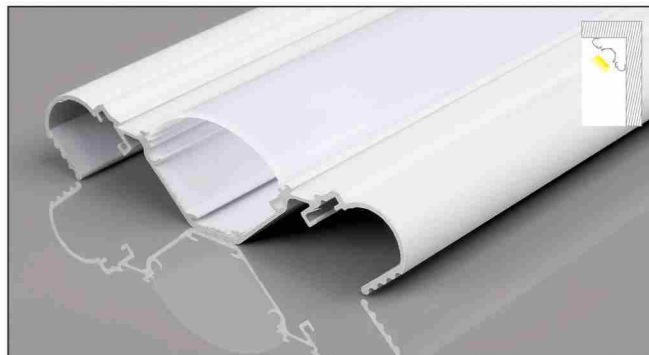
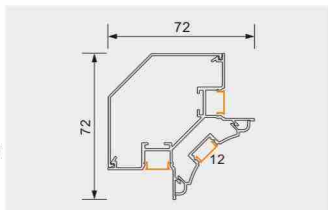

XT647

产品参数 **7272顶角线**

尺寸: Lx72.4x72.4mm
表面: 氧化铝本色/喷漆 (黑色/白色/玫瑰金)
PC罩: 乳白/黑色/亚克力磨砂可选
适用: 12MM软灯带

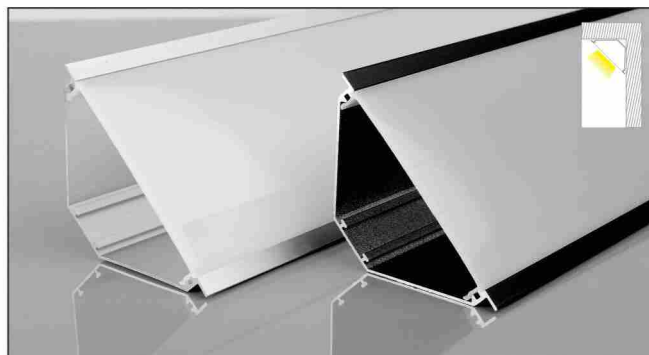
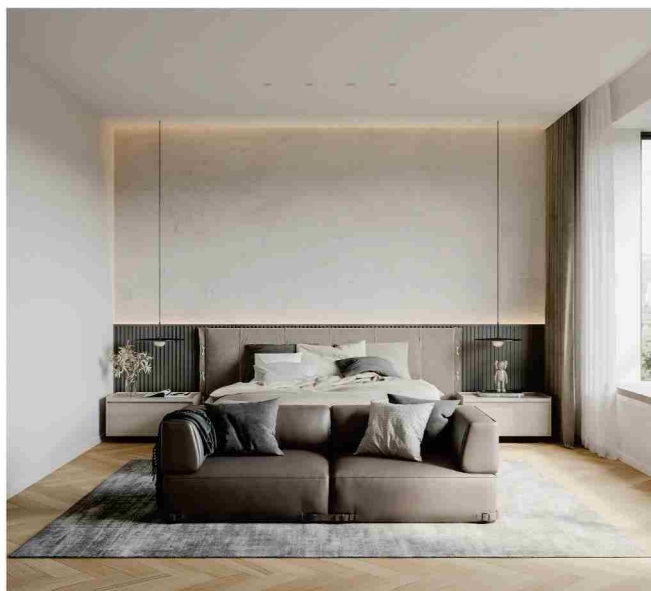
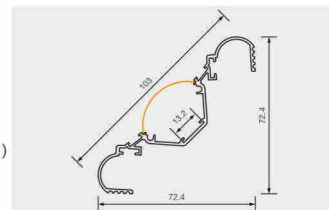

XT587

产品参数 **9036顶角线**

尺寸: Lx90x36.3mm
表面: 氧化铝本色/喷漆 (黑色/白色/玫瑰金)
PC罩: 乳白/黑色/亚克力磨砂可选
适用: 19MM软灯带

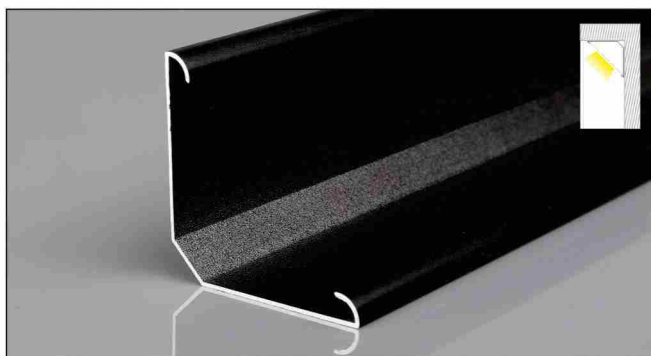
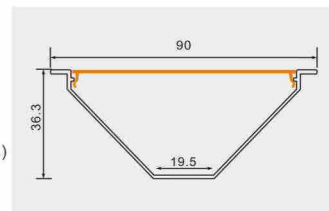

XT642

产品参数 **7333顶角线**

尺寸: Lx73x33mm
表面: 氧化铝本色/喷漆 (黑色/白色/玫瑰金)
PC罩: 乳白/黑色/亚克力磨砂可选
适用: 11MM软灯带

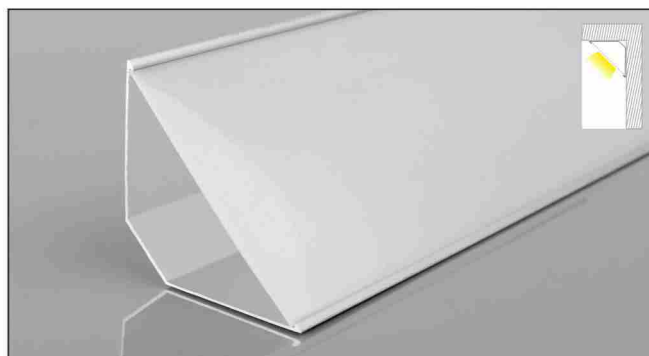
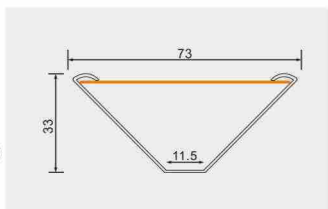

XT641

产品参数 **8431顶角线**

尺寸: Lx84x31mm
表面: 氧化铝本色/喷漆 (黑色/白色/玫瑰金)
PC罩: 乳白/黑色/亚克力磨砂可选
适用: 20MM软灯带

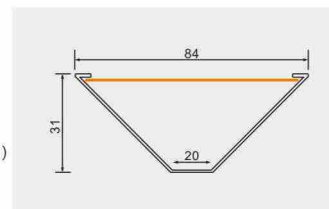

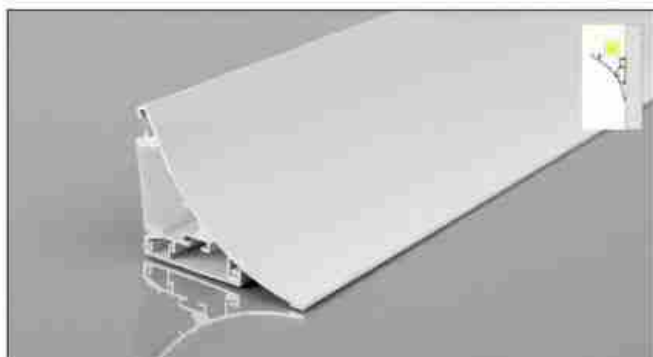

XT683+684

产品参数 **3750腰线壁灯**

尺寸: Lx37x50.4mm
 表面: 氧化铝本色/喷漆 (黑色/白色)
 PC罩: 乳白/黑色/亚克力磨砂可选
 适用: 14MM软灯带/硬灯条

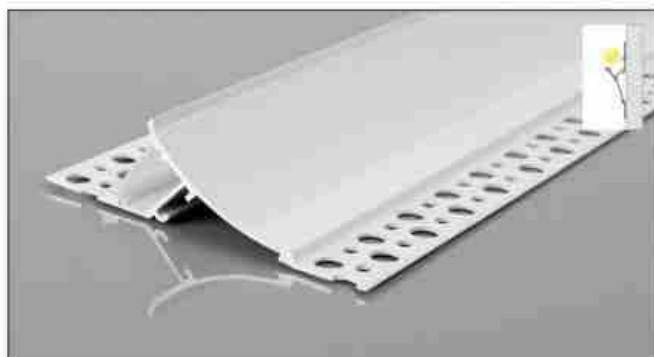

XT544

产品参数 **9826洗墙灯**

尺寸: Lx97.8x26.4mm
 表面: 氧化铝本色/喷漆 (黑色/白色)
 PC罩: 乳白/黑色/亚克力磨砂可选
 适用: 15MM软灯带/硬灯条

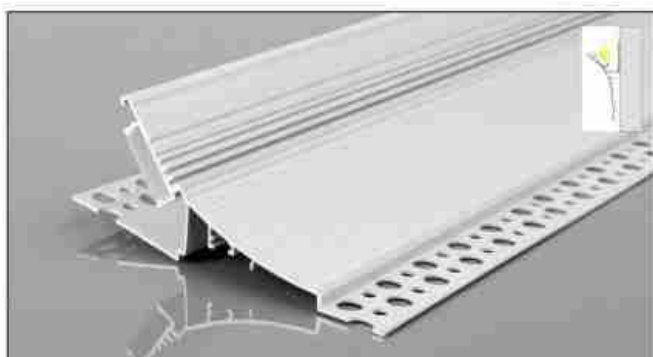

XT544

产品参数 **10843洗墙灯**

尺寸: Lx108x43mm
 表面: 氧化铝本色/喷漆 (黑色/白色)
 PC罩: 乳白/黑色/亚克力磨砂可选
 适用: 20MM软灯带/硬灯条

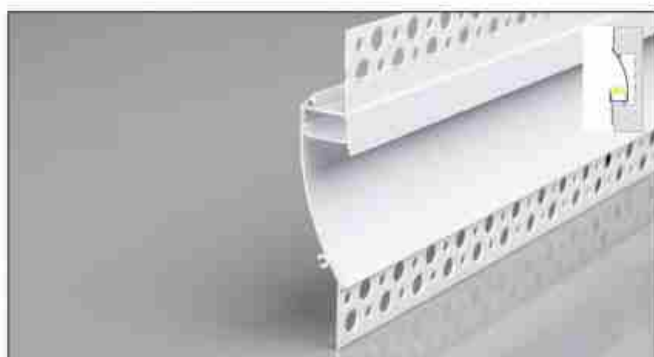

XT585

产品参数 **9819回光**

尺寸: Lx98x19mm
 表面: 氧化铝本色/喷漆 (黑色/白色/玫瑰金)
 PC罩: 乳白/黑色/亚克力磨砂可选
 适用: 14MM软灯带

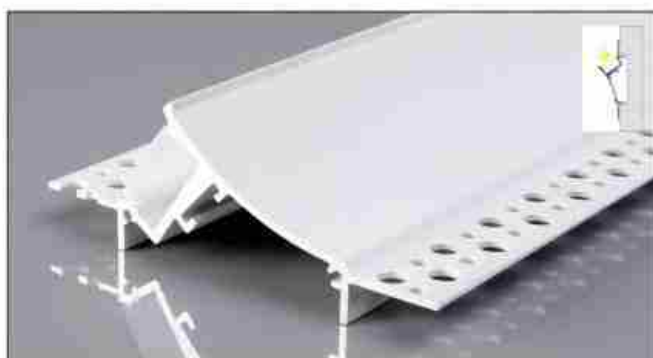
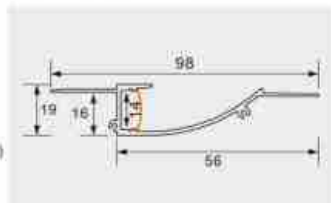

XT533

产品参数 **9836洗墙灯**

尺寸: Lx98x36mm
 表面: 氧化铝本色/喷漆 (黑色/白色)
 PC罩: 乳白/黑色/亚克力磨砂可选
 适用: 20MM软灯带/硬灯条

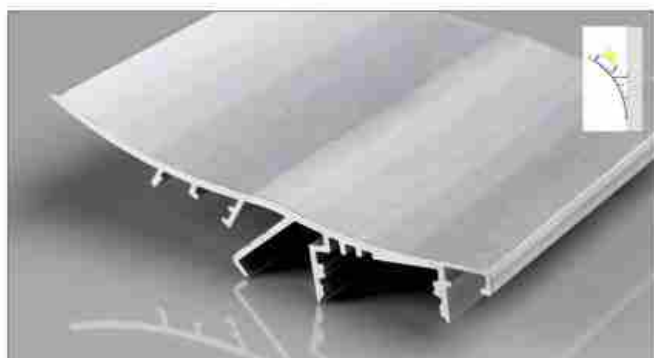

XT564

产品参数 **7044洗墙灯**

尺寸: Lx69.3x43.5mm
 表面: 氧化铝本色/喷漆 (黑色/白色)
 PC罩: 乳白/黑色/亚克力磨砂可选
 适用: 20MM软灯带/硬灯条



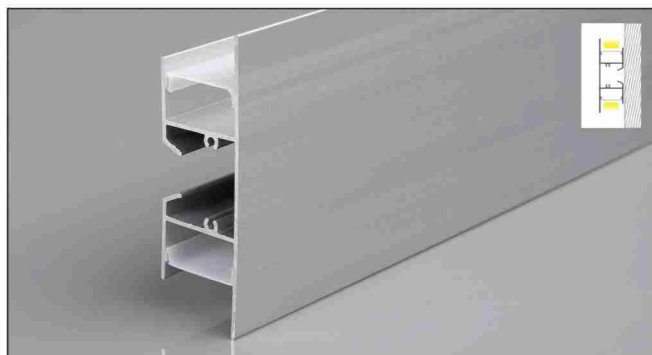

XT572

产品参数 7525壁灯

尺寸: Lx75.3x24.5mm
表面: 氧化铝本色/喷漆 (黑色/白色/玫瑰金)
PC罩: 乳白/黑色/亚克力磨砂可选
适用: 22MM软灯带

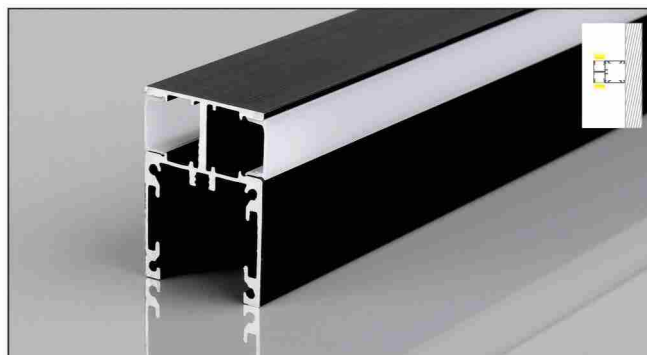
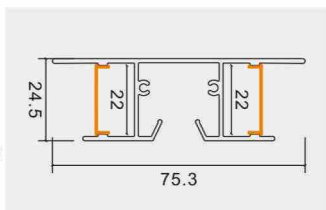

XT574

产品参数 3626壁灯

尺寸: Lx36x26.4.5mm
表面: 氧化铝本色/喷漆 (黑色/白色/玫瑰金)
PC罩: 乳白/黑色/亚克力磨砂可选
适用: 12MM软灯带

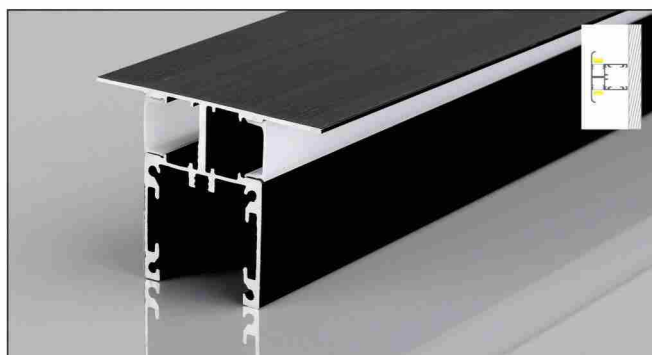
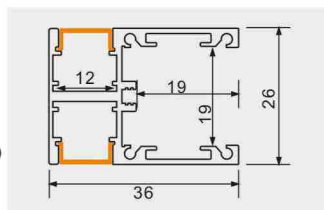

XT575

产品参数 4537壁灯

尺寸: Lx45x26mm
表面: 氧化铝本色/喷漆 (黑色/白色/玫瑰金)
PC罩: 乳白/黑色/亚克力磨砂可选
适用: 12MM软灯带

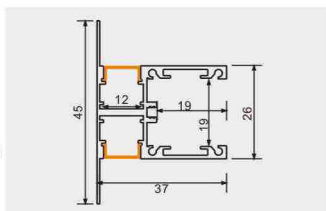

XT511/512

产品参数 龙骨组合

尺寸: Lx28x29mm
表面: 氧化铝本色/喷漆 (黑色/白色)
PC罩: 乳白
适用: 15MM软灯带/硬灯条

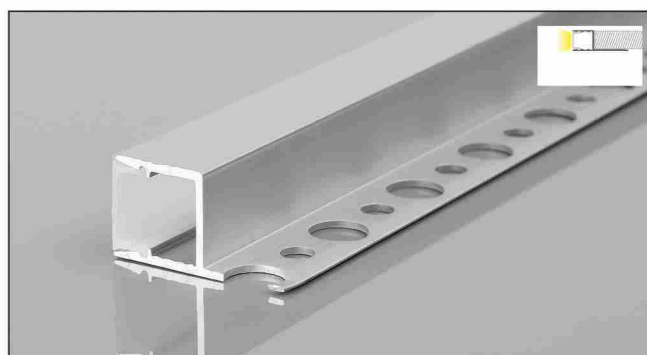
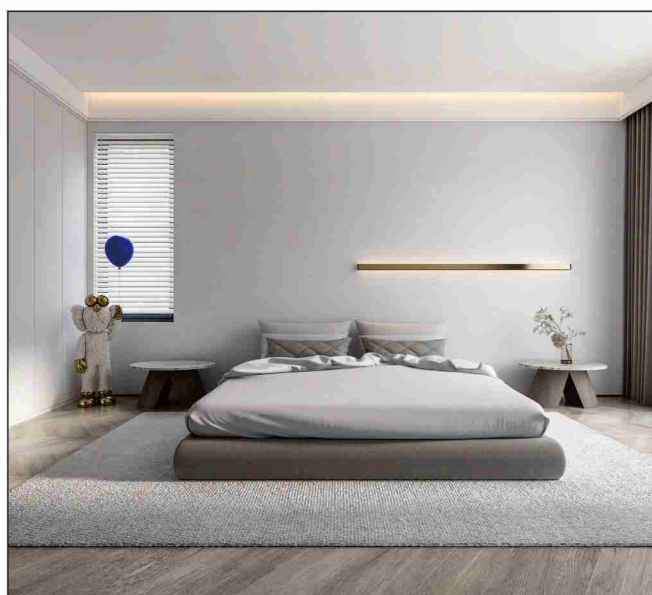
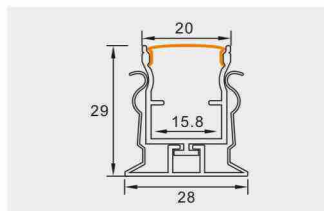

XT759

产品参数 单排孔13侧花边

尺寸: Lx23.5x12.3mm
表面: 氧化铝本色/喷漆 (黑色/白色/玫瑰金)
PC罩: 乳白/黑色/亚克力磨砂可选
适用: 10MM软灯带

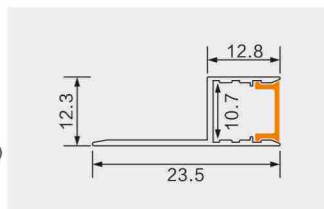

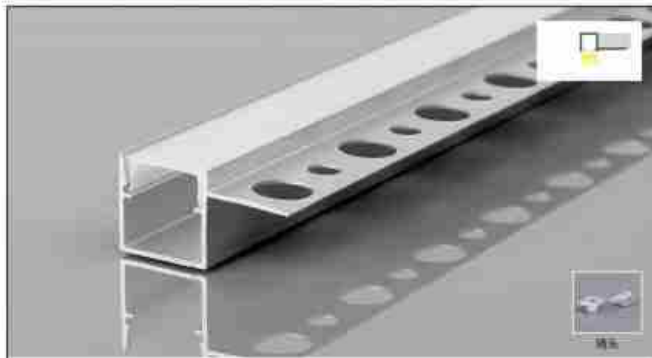

XT756

产品参数 **单排孔13单上花边**

尺寸: Lx23.3x13mm
 表面: 氧化铝本色/喷漆 (黑色/白色)
 PC罩: 乳白/黑色/亚克力磨砂可选
 适用: 10MM软灯带/硬灯条

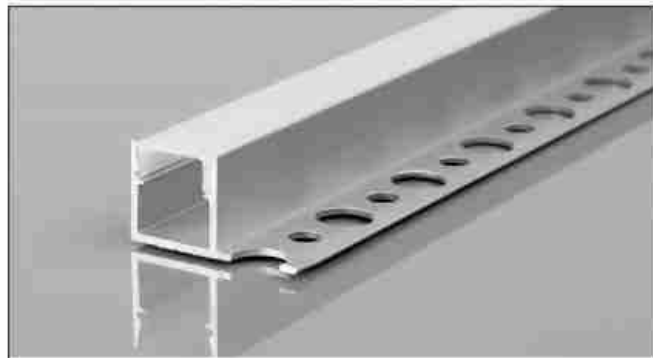
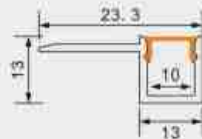

XT755

产品参数 **单排孔13单下花边**

尺寸: Lx23.3x13mm
 表面: 氧化铝本色/喷漆 (黑色/白色)
 PC罩: 乳白/黑色/亚克力磨砂可选
 适用: 10MM软灯带/硬灯条

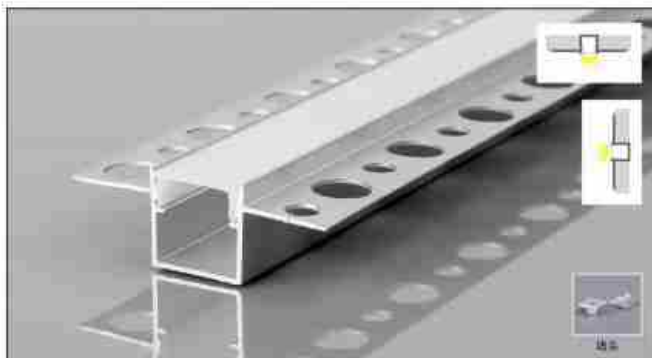
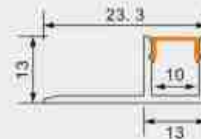

XT758

产品参数 **单排孔13双上花边**

尺寸: Lx34.3x13mm
 表面: 氧化铝本色/喷漆 (黑色/白色)
 PC罩: 乳白/黑色/亚克力磨砂可选
 适用: 10MM软灯带/硬灯条

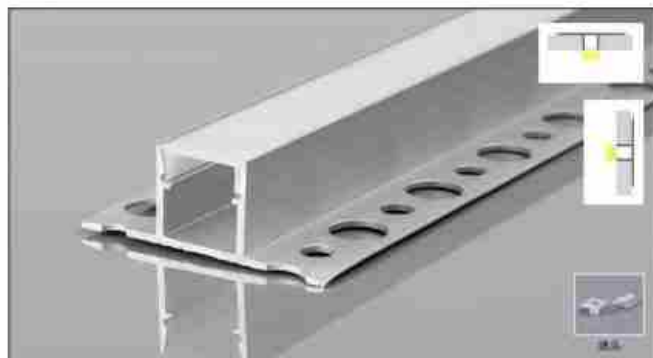
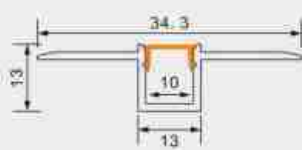

XT757

产品参数 **单排孔13双下花边**

尺寸: Lx34.3x13mm
 表面: 氧化铝本色/喷漆 (黑色/白色)
 PC罩: 乳白/黑色/亚克力磨砂可选
 适用: 10MM软灯带/硬灯条

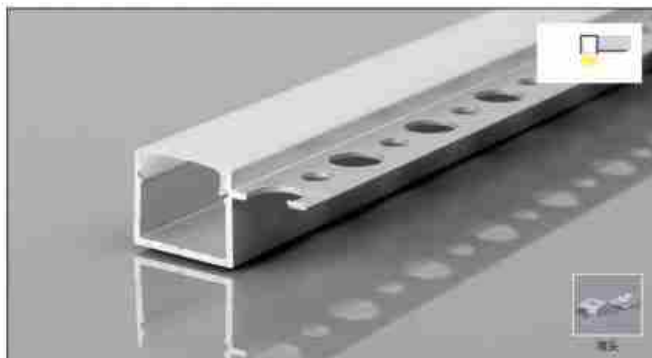
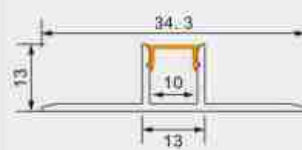

XT760

产品参数 **单排孔15单上花边**

尺寸: Lx26.3x13mm
 表面: 氧化铝本色/喷漆 (黑色/白色)
 PC罩: 乳白/黑色/亚克力磨砂可选
 适用: 12MM软灯带/硬灯条

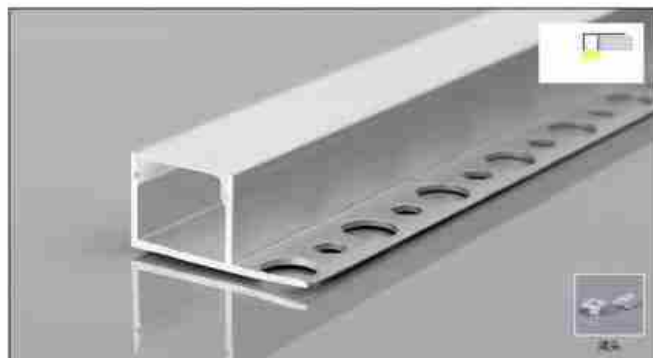
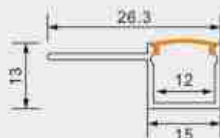

XT761

产品参数 **单排孔15单下花边**

尺寸: Lx26.3x13mm
 表面: 氧化铝本色/喷漆 (黑色/白色)
 PC罩: 乳白/黑色/亚克力磨砂可选
 适用: 12MM软灯带/硬灯条



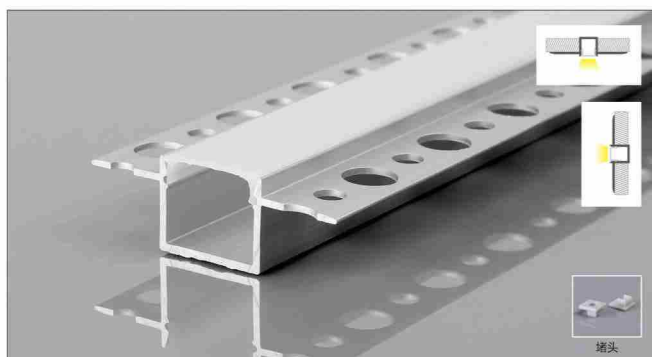

XT763

产品参数 **单排孔15双上花边**

尺寸: Lx37.3x13mm
表面: 氧化铝本色/喷漆 (黑色/白色)
PC罩: 乳白/黑色/亚克力磨砂可选
适用: 12MM软灯带/硬灯条

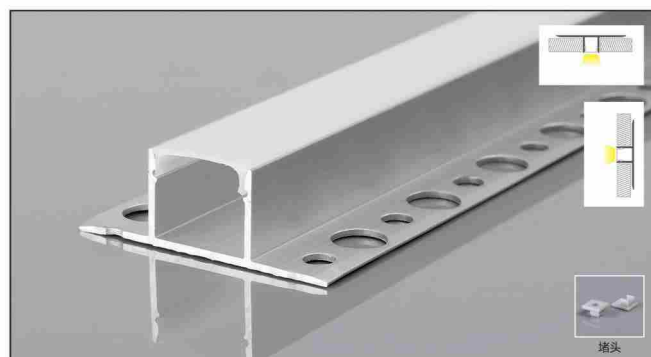
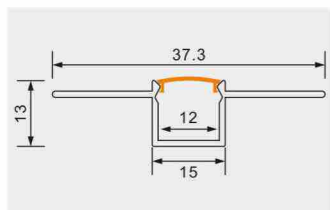

XT732

产品参数 **单排孔15双下花边**

尺寸: Lx37.3x13mm
表面: 氧化铝本色/喷漆 (黑色/白色)
PC罩: 乳白/黑色/亚克力磨砂可选
适用: 12MM软灯带/硬灯条

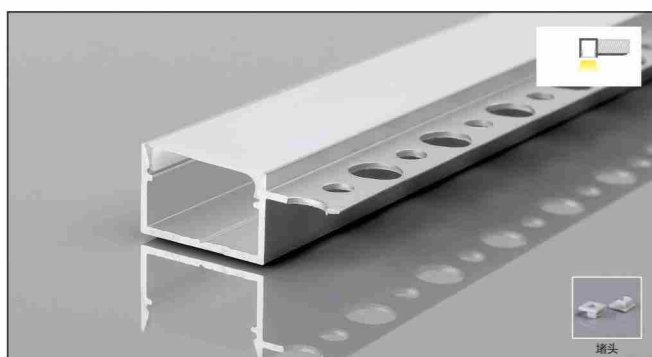
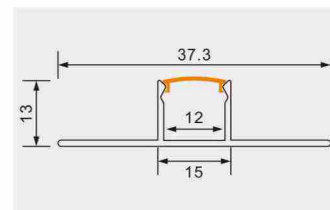

XT765

产品参数 **单排孔20单上花边**

尺寸: Lx31x13mm
表面: 氧化铝本色/喷漆 (黑色/白色)
PC罩: 乳白/黑色/亚克力磨砂可选
适用: 17MM软灯带/硬灯条

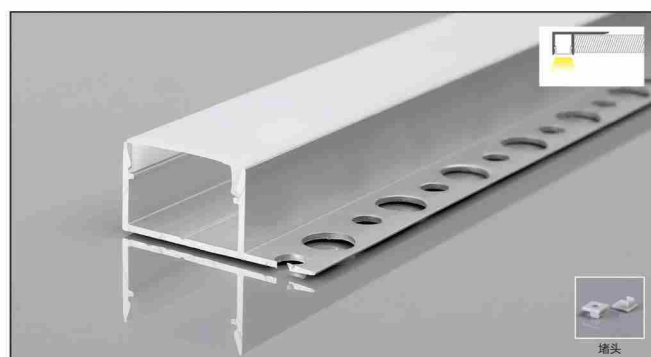
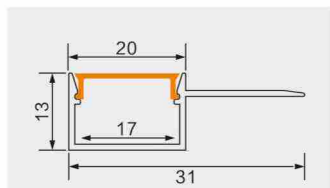

XT764

产品参数 **单排孔20单下花边**

尺寸: Lx31x13mm
表面: 氧化铝本色/喷漆 (黑色/白色/玫瑰金)
PC罩: 乳白/黑色/亚克力磨砂可选
适用: 17MM软灯带

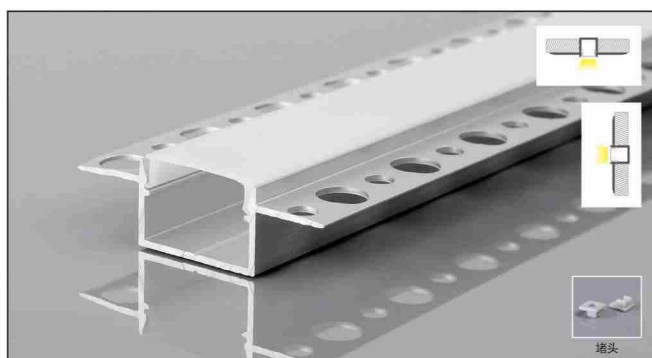
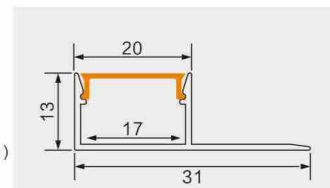

XT767

产品参数 **单排孔20双上花边**

尺寸: Lx41.860x13mm
表面: 氧化铝本色/喷漆 (黑色/白色)
PC罩: 乳白/黑色/亚克力磨砂可选
适用: 17MM软灯带/硬灯条

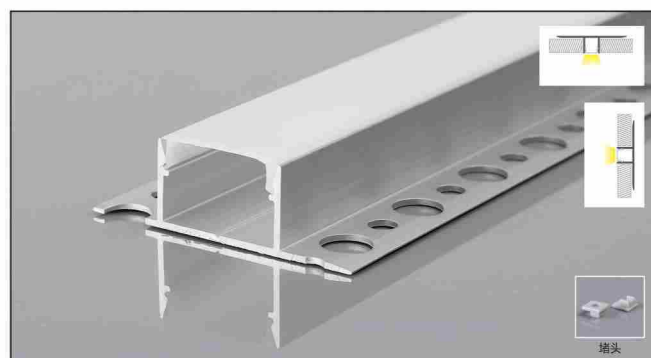
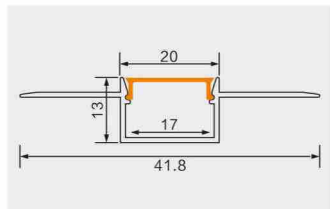

XT766

产品参数 **单排孔20双下花边**

尺寸: Lx41.8x13mm
表面: 氧化铝本色/喷漆 (黑色/白色)
PC罩: 乳白/黑色/亚克力磨砂可选
适用: 17MM软灯带/硬灯条

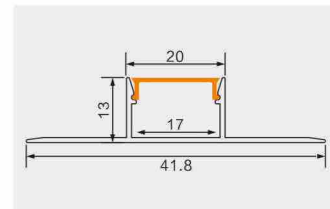

P49-P58

衣柜橱柜灯

铝型材套件

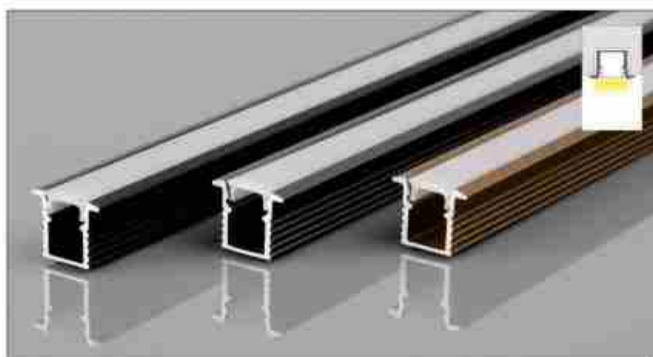

JP30

产品参数 免焊0808带边

尺寸: Lx10.8x7.8mm
表面: 氧化 (黑色/金色/银灰色)
PC罩: 乳白/黑色/亚克力磨砂可选
适用: 5MM软灯带/硬灯条

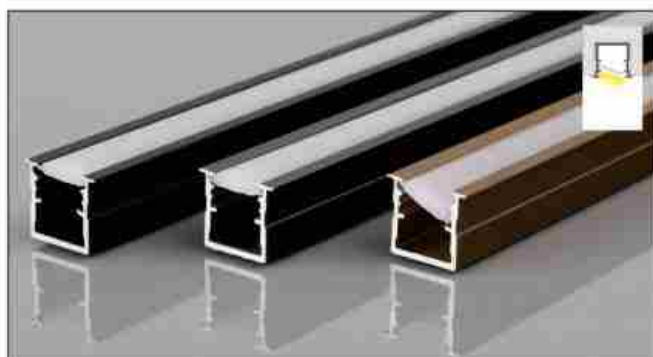
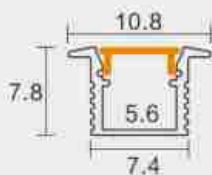

JP29

产品参数 免焊1010带边

尺寸: Lx11.6x10mm
表面: 氧化 (黑色/金色/银灰色)
PC罩: 乳白/黑色/亚克力磨砂可选
适用: 8MM软灯带/硬灯条

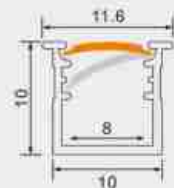

JP08

产品参数 1010带边斜光

尺寸: Lx12.9x10.3mm
表面: 氧化 (黑色/金色/银灰色)
PC罩: 乳白/黑色/亚克力磨砂可选
适用: 5MM软灯带

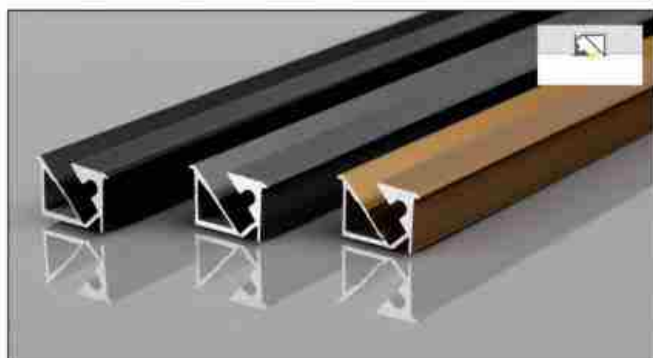
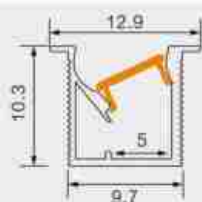

JP27硅胶款

产品参数 1309带边斜光

尺寸: Lx14.7x8.9mm
表面: 氧化 (黑色/金色/银灰色)
PC罩: 乳白/黑色/亚克力磨砂可选
适用: 5MM软灯带

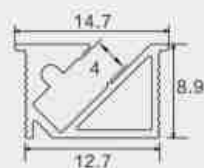

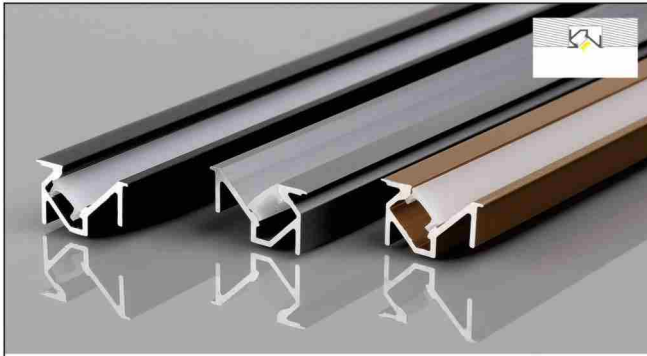

JP25

产品参数 **1510带边斜光**

尺寸: Lx17x10mm
表面: 氧化 (黑色/金色/铁灰色)
PC罩: 乳白/黑色/亚克力磨砂可选
适用: 5MM软灯带

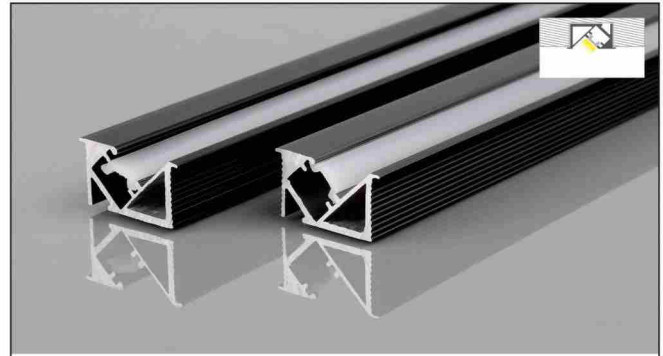
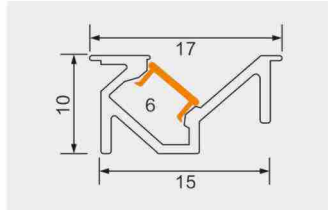

JP20

产品参数 **1710带边斜光**

尺寸: Lx19.6x10mm
表面: 氧化 (黑色/金色/铁灰色)
PC罩: 乳白/黑色/亚克力磨砂可选
适用: 8MM软灯带

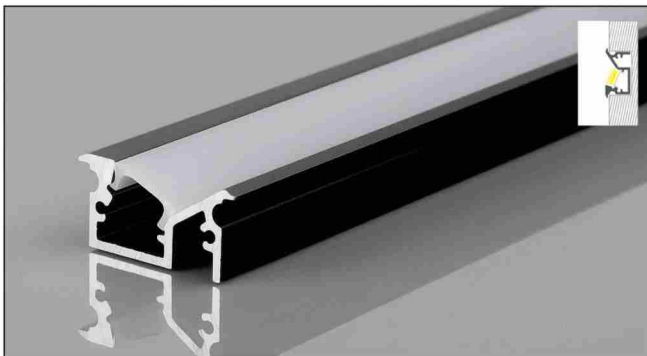
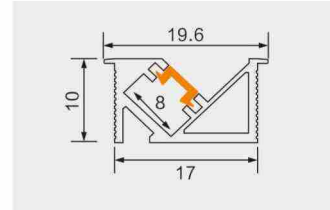

XT284

产品参数 **2010橱柜层板**

尺寸: Lx20x10mm
表面: 氧化铝本色/喷漆 (黑色/白色)
PC罩: 乳白/黑色/亚克力磨砂可选
适用: 8MM软灯带/硬灯条

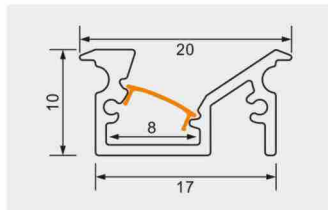

XT342

产品参数 **2308橱柜层板**

尺寸: Lx23x8mm
表面: 氧化铝本色/喷漆 (黑色/白色)
PC罩: 乳白/黑色/亚克力磨砂可选
适用: 5MM软灯带

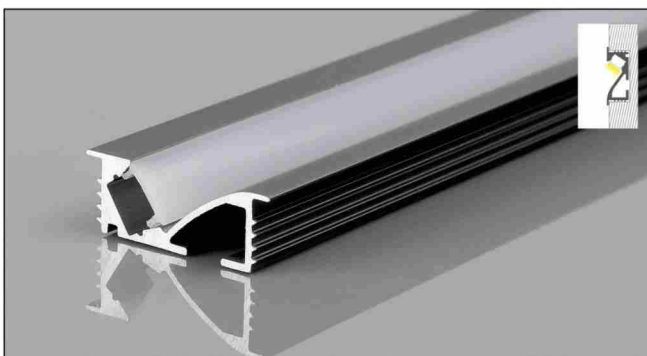
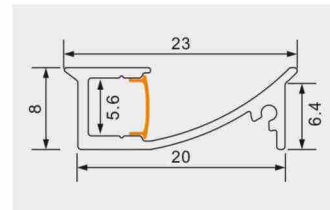

XT329

产品参数 **2409橱柜层板**

尺寸: Lx23.8x8.8mm
表面: 氧化铝本色/喷漆 (黑色/白色/玫瑰金)
PC罩: 乳白/黑色/亚克力磨砂可选
适用: 5MM软灯带

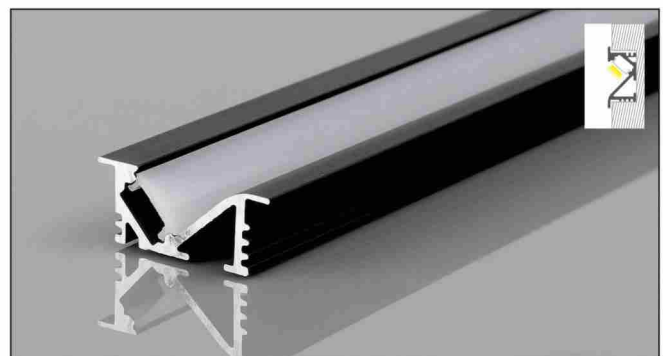
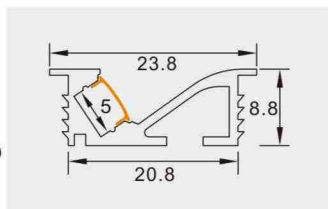

XT333

产品参数 **2108橱柜层板**

尺寸: Lx21x08mm
表面: 氧化铝本色/喷漆 (黑色/白色/玫瑰金)
PC罩: 乳白/黑色/亚克力磨砂可选
适用: 5MM软灯带

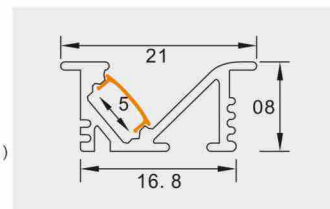



JP23

产品参数 **0808三角**

尺寸: Lx8x8mm
 表面: 氧化 (黑色/金色/钛灰色)
 PC罩: 乳白/黑色/亚克力磨砂可选
 适用: 4MM灯带

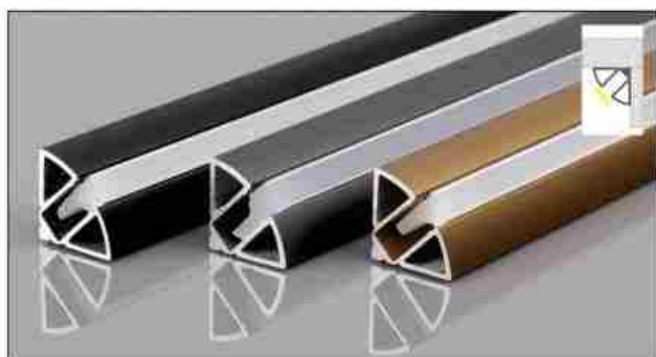
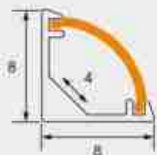

JP02硅胶款

产品参数 **11*11三角**

尺寸: Lx11.4x11.4mm
 表面: 氧化 (黑色/金色/钛灰色)
 PC罩: 乳白/黑色/亚克力磨砂可选
 适用: 5MM灯带

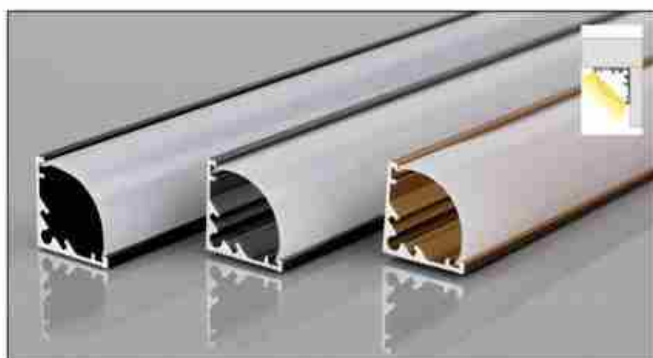
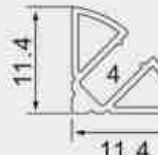

JP16

产品参数 **1616三角**

尺寸: Lx15.7x15.7mm
 表面: 氧化 (黑色/金色/钛灰色)
 PC罩: 乳白/黑色/亚克力磨砂可选
 适用: 7MM灯带

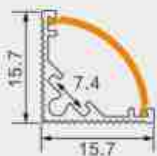

JP07硅胶款

产品参数 **1808明装**

尺寸: Lx17.6x8mm
 表面: 氧化 (黑色/金色/钛灰色)
 PC罩: 乳白/黑色/亚克力磨砂可选
 适用: 5MM灯带

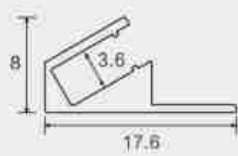

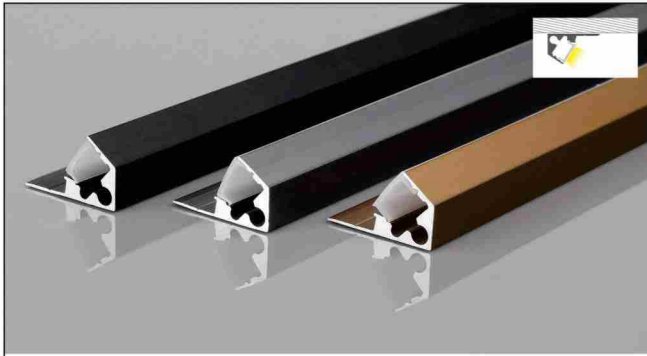

JP05

产品参数 **2112明装**

尺寸: Lx20.6x12.1mm
表面: 氧化(黑色/金色/铁灰色)
PC罩: 乳白/黑色/亚克力磨砂可选
适用: 9MM软灯带

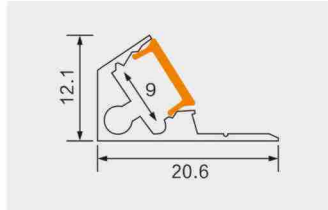

JP15

产品参数 **2412明装**

尺寸: Lx23.5x12mm
表面: 氧化(黑色/金色/铁灰色)
PC罩: 乳白/黑色/亚克力磨砂可选
适用: 8MM软灯带

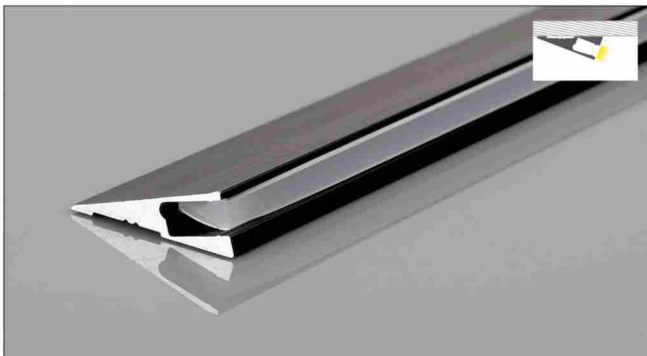
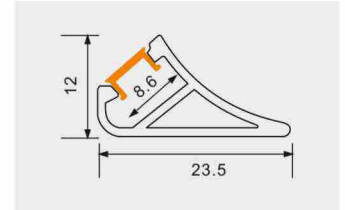

JP06硅胶款

产品参数 **2308明装**

尺寸: Lx22.6x8mm
表面: 氧化(黑色/金色/铁灰色)
PC罩: 乳白/黑色/亚克力磨砂可选
适用: 5MM软灯带

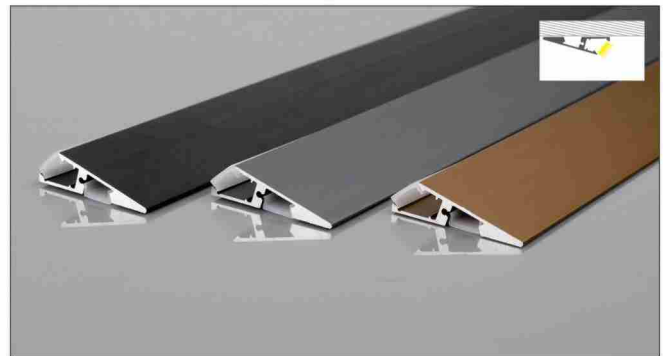
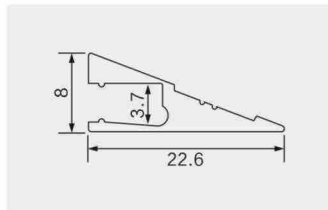

JP04

产品参数 **3210明装**

尺寸: Lx29x10mm
表面: 氧化(黑色/金色/铁灰色)
PC罩: 乳白/黑色/亚克力磨砂可选
适用: 5MM软灯带

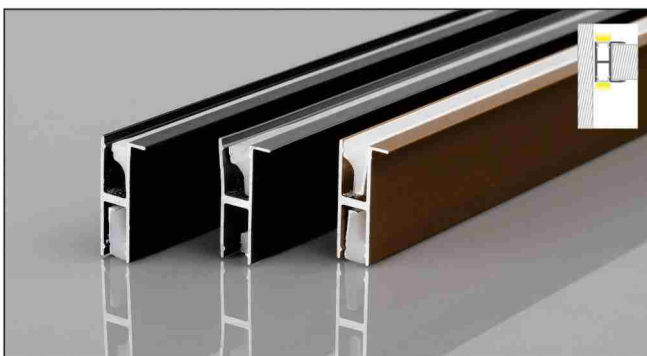
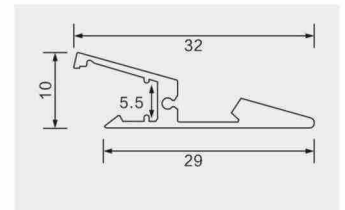

XT471硅胶款

产品参数 **0618后置活动**

尺寸: Lx8.5x18mm
表面: 氧化(黑色/金色/铁灰色)
PC罩: 乳白/黑色/亚克力磨砂可选
适用: 5MM软灯带

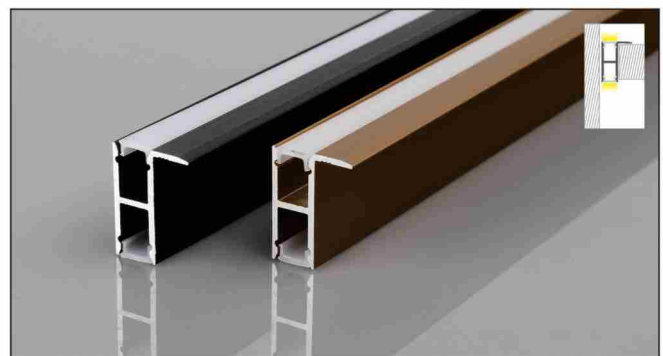
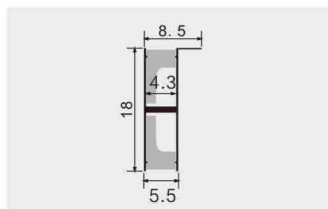

JP26

产品参数 **1520后置活动**

尺寸: Lx15x20mm
表面: 氧化(黑色/金色/铁灰色)
PC罩: 乳白/黑色/亚克力磨砂可选
适用: 5MM软灯带

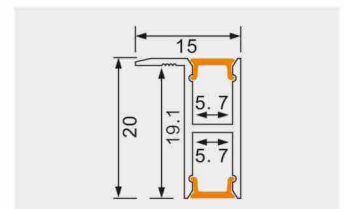

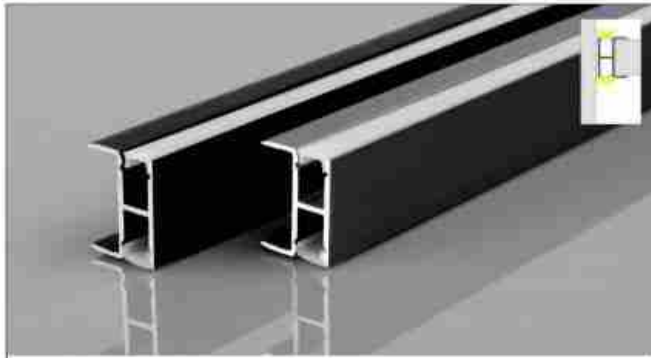

JP17

产品参数 **1520后置夹板**

尺寸: Lx15x20mm
 表面: 氧化 (黑色/金色/钛灰色)
 PC罩: 乳白/黑色/亚克力磨砂可选
 适用: 5MM软灯带

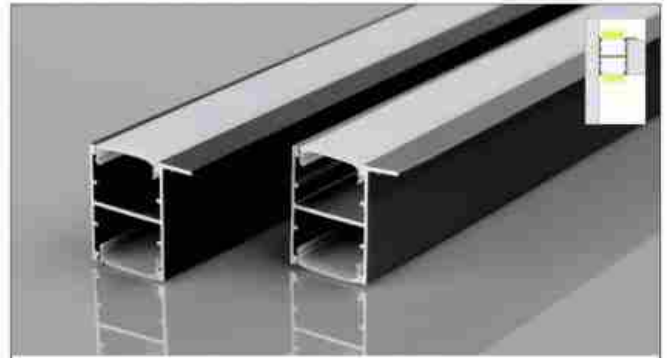

XT687

产品参数 **2020后置活动**

尺寸: Lx20x20mm
 表面: 氧化 (黑色/金色/钛灰色)
 PC罩: 乳白/黑色/亚克力磨砂可选
 适用: 12MM软灯带

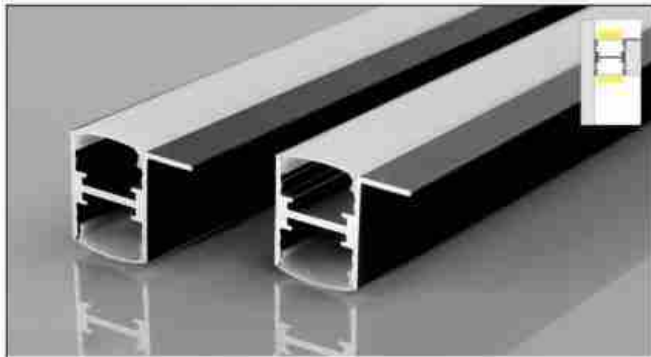
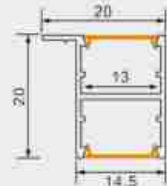

JP24

产品参数 **2620后置活动**

尺寸: Lx25.9x18.9mm
 表面: 氧化 (黑色/金色/钛灰色)
 PC罩: 乳白/黑色/亚克力磨砂可选
 适用: 11MM软灯带

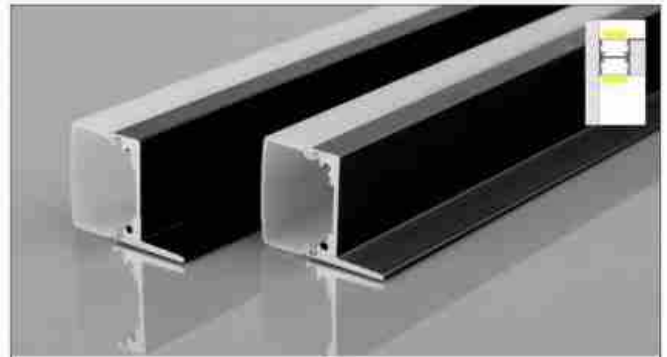
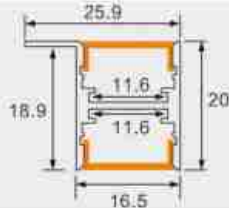

XT493

产品参数 **2520后置活动**

尺寸: Lx25.5x20mm
 表面: 氧化 (黑色/金色/钛灰色)
 PC罩: 乳白/黑色/亚克力磨砂可选
 适用: 8MM软灯带

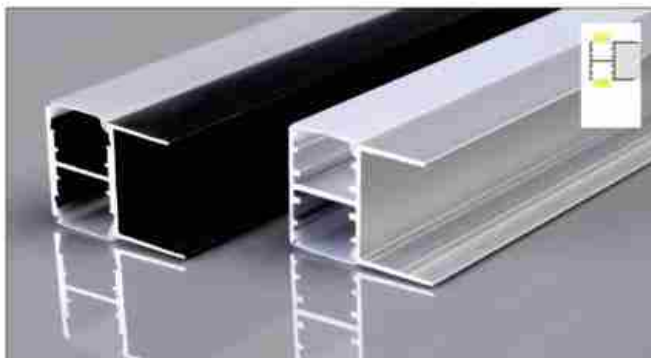
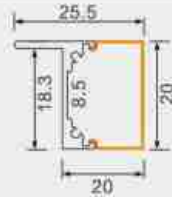

XT345

产品参数 **2820后置夹板**

尺寸: Lx28x20mm
 表面: 氧化铝本色/喷漆 (黄色/白色)
 PC罩: 乳白/黑色/亚克力磨砂可选
 适用: 12MM软灯带/硬灯条

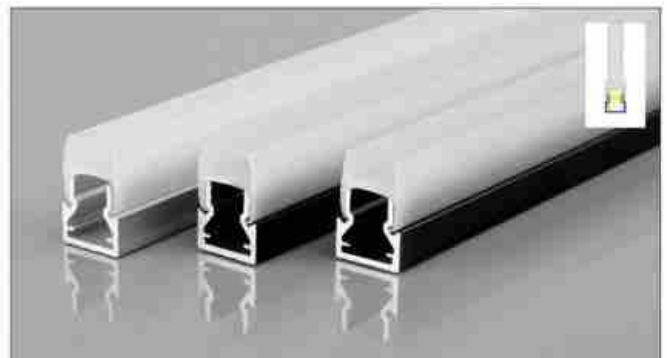
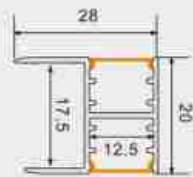

XT319

产品参数 **1117玻璃层板**

尺寸: Lx11.2x17.3mm
 表面: 氧化 (黑色/金色/钛灰色)
 PC罩: 乳白
 适用: 8MM软灯带/硬灯条



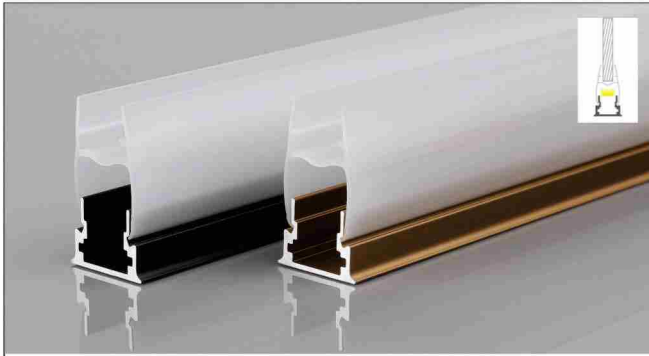

XT291

产品参数 **1731玻璃层板**

尺寸: Lx17x31mm
表面: 氧化铝本色/喷漆 (黑色/白色)
PC罩: 乳白
适用: 10MM软灯带/硬灯条

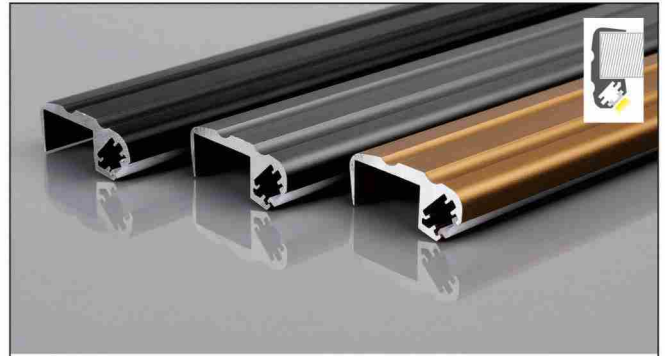
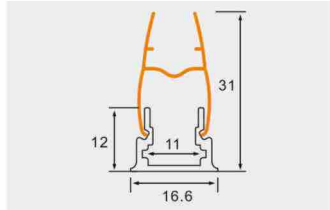

JP13

产品参数 **1230前置层板**

尺寸: Lx30.6x12.3mm
表面: 氧化 (黑色/金色/铁灰色)
PC罩: 乳白/黑色/亚克力磨砂可选
适用: 7MM软灯带

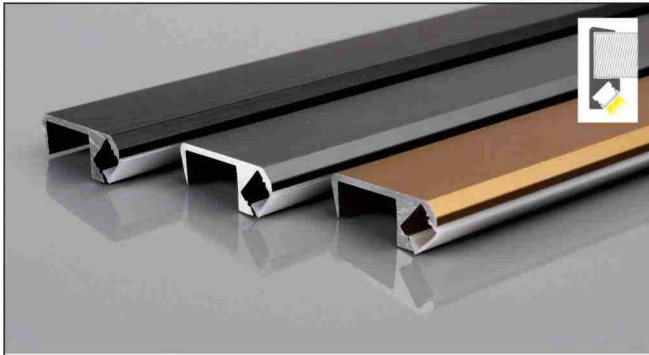
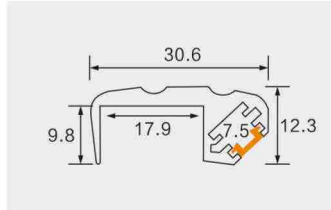

JP12

产品参数 **1232前置层板**

尺寸: Lx31.7x11.6mm
表面: 氧化 (黑色/金色/铁灰色)
PC罩: 乳白/黑色/亚克力磨砂可选
适用: 9MM软灯带

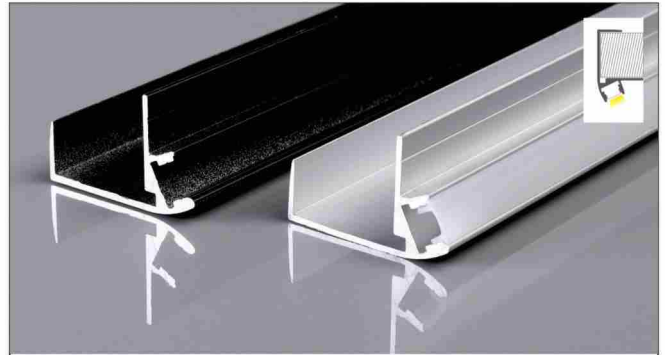
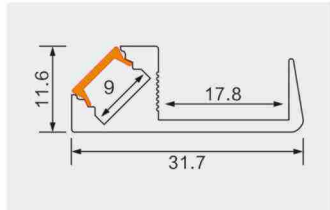

XT321

产品参数 **1829层板**

尺寸: Lx18.5x29mm
表面: 氧化铝本色/喷漆 (黑色/白色)
PC罩: 乳白/黑色/亚克力磨砂可选
适用: 5MM软灯带

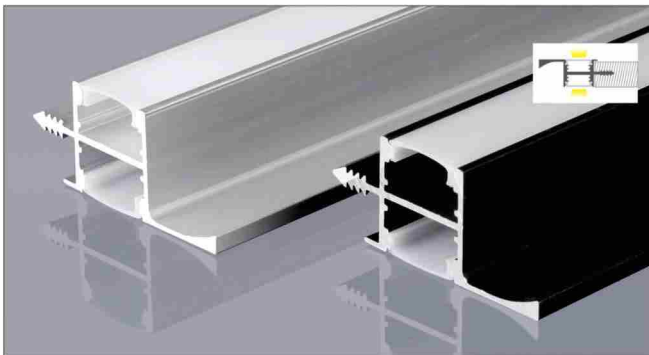
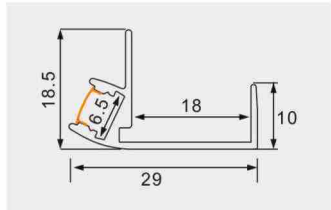

XT548

产品参数 **3819层板**

尺寸: Lx38x19mm
表面: 氧化铝本色/喷漆 (黑色/白色)
PC罩: 乳白/黑色/亚克力磨砂可选
适用: 12MM软灯带

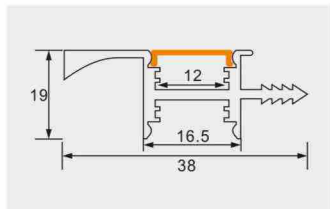

XT231B

产品参数 **0809PC带边**

尺寸: Lx7.8x9mm
表面: 氧化 (黑色/金色/铁灰色)
PC罩: 乳白/黑色/亚克力磨砂可选
适用: 5MM软灯带

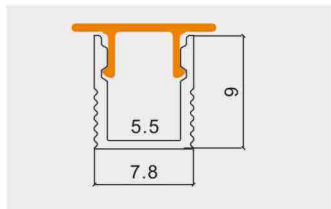

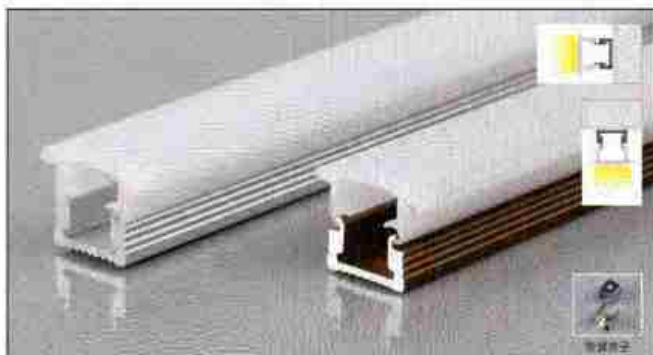

XT301

产品参数 1011PC带边

尺寸: Lx10x11mm
 表面: 氧化铝本色/喷漆 (黑色/白色)
 PC罩: 乳白
 适用: 7MM软灯带/硬灯条

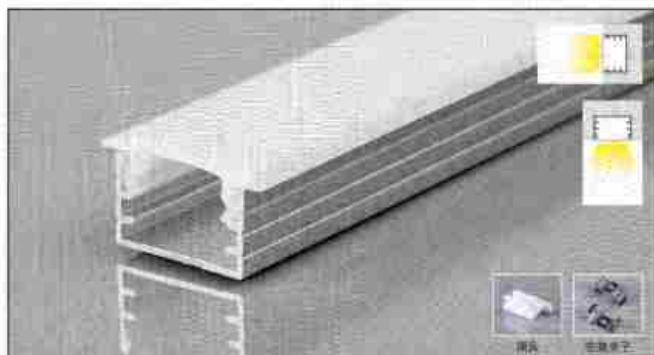
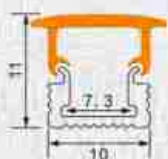

XT298B

产品参数 1509PC带边

尺寸: Lx18.5x9.6mm
 表面: 氧化铝本色/喷漆 (黑色/白色)
 PC罩: 乳白
 适用: 12MM软灯带/硬灯条

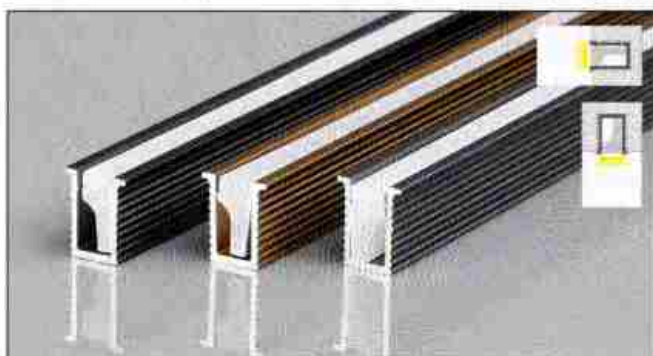
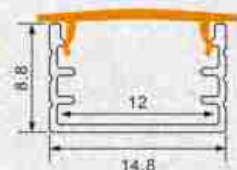

JP03硅胶款

产品参数 0610带边

尺寸: Lx6.9x9.5mm
 表面: 氧化 (黑色/金色/钛灰色)
 PC罩: 乳白/黑色/亚克力磨砂可选
 适用: 5MM软灯带

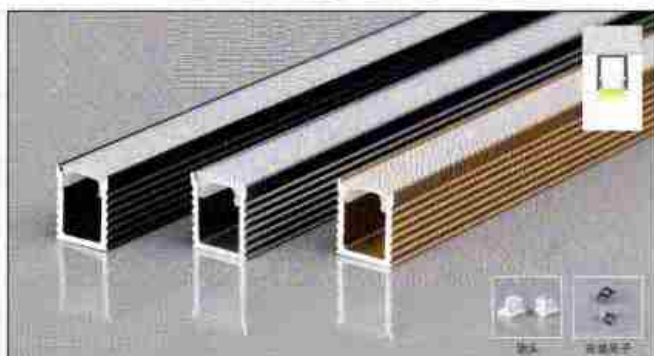
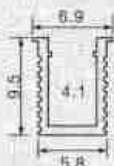

XT231

产品参数 0809

尺寸: Lx7.8x9mm
 表面: 氧化 (黑色/金色/钛灰色)
 PC罩: 乳白/黑色/亚克力磨砂可选
 适用: 5MM软灯带



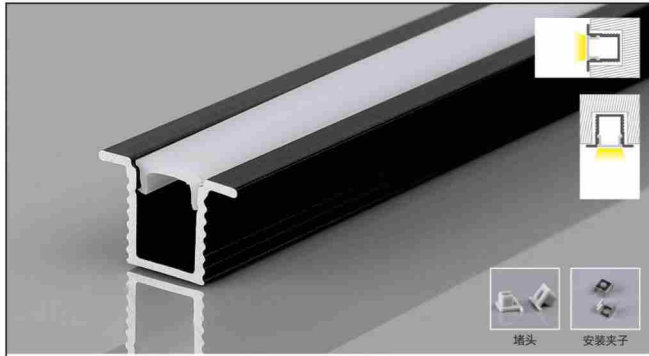

XT293

0809带边

产品参数
尺寸: Lx12.8x9mm
表面: 氧化(黑色/金色/铁灰色)
PC罩: 乳白/黑色/亚克力磨砂可选
适用: 5MM软灯带

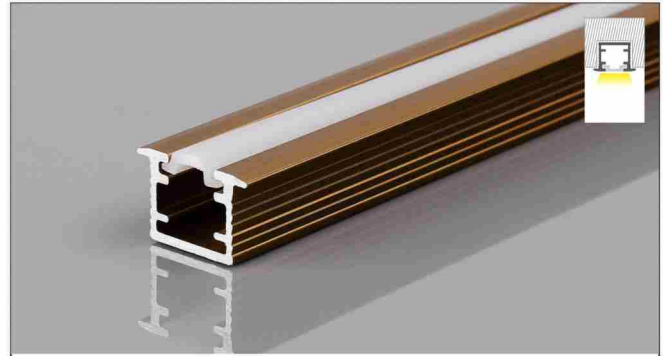
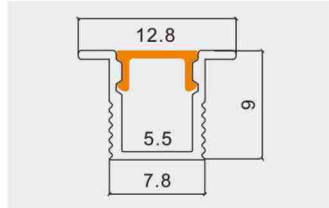

JP21

1009带边

产品参数
尺寸: Lx13.2x9mm
表面: 氧化(黑色/金色/铁灰色)
PC罩: 乳白/黑色/亚克力磨砂可选
适用: 8MM软灯带/硬灯条

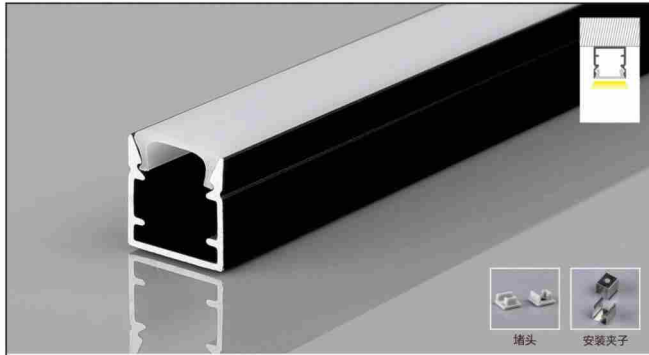
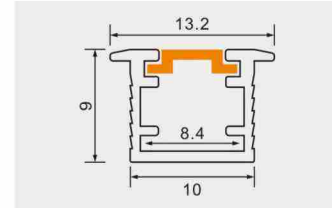

XT453

1010带边

产品参数
尺寸: Lx10x10mm
表面: 氧化(黑色/金色/铁灰色)
PC罩: 乳白/黑色/亚克力磨砂可选
适用: 108MM软灯带/硬灯条

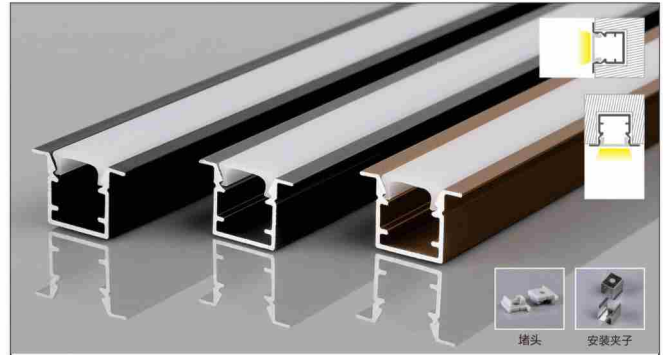
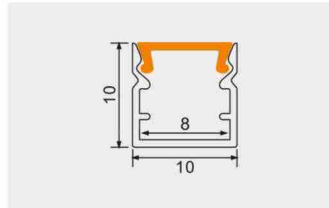

XT454

1010带边

产品参数
尺寸: Lx15x10mm
表面: 氧化(黑色/金色/铁灰色)
PC罩: 乳白/黑色/亚克力磨砂可选
适用: 8MM软灯带/硬灯条

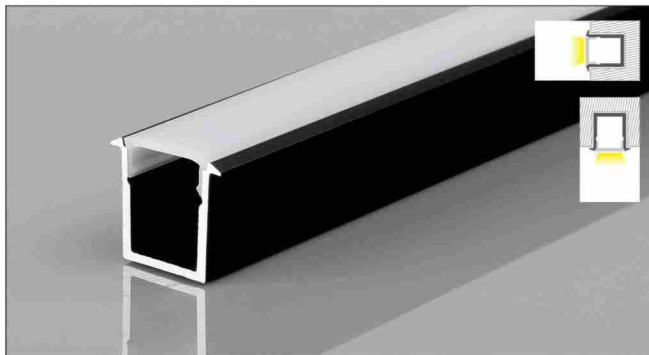
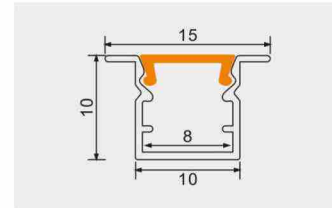

JP18

1011带边

产品参数
尺寸: Lx12.8x10.9mm
表面: 氧化(黑色/金色/铁灰色)
PC罩: 乳白/黑色/亚克力磨砂可选
适用: 5MM软灯带

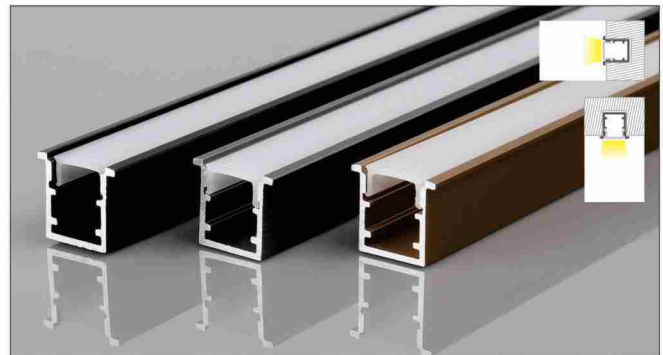
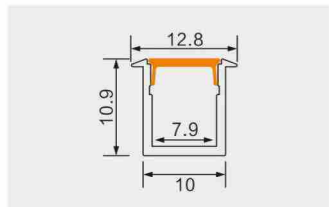

JP22

1112带边

产品参数
尺寸: Lx13.2x12mm
表面: 氧化(黑色/金色/铁灰色)
PC罩: 乳白/黑色/亚克力磨砂可选
适用: 8MM软灯带

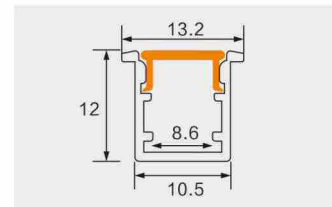

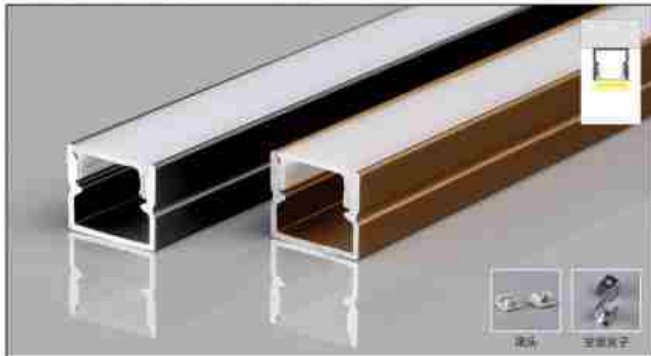

XT537

产品参数 **1210**

尺寸: Lx12x10mm
 表面: 氧化 (黑色/金色/铁灰色)
 PC罩: 乳白/黑色/亚克力磨砂可选
 适用: 10MM软灯带/硬灯条

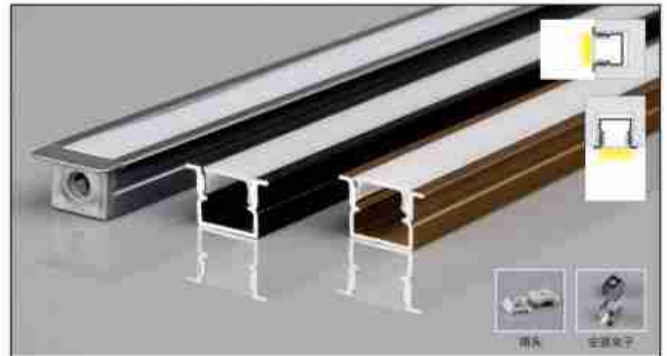
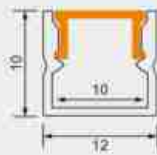

XT538

产品参数 **1210带边**

尺寸: Lx16x10mm
 表面: 氧化 (黑色/金色/铁灰色)
 PC罩: 乳白/黑色/亚克力磨砂可选
 适用: 10MM软灯带/硬灯条

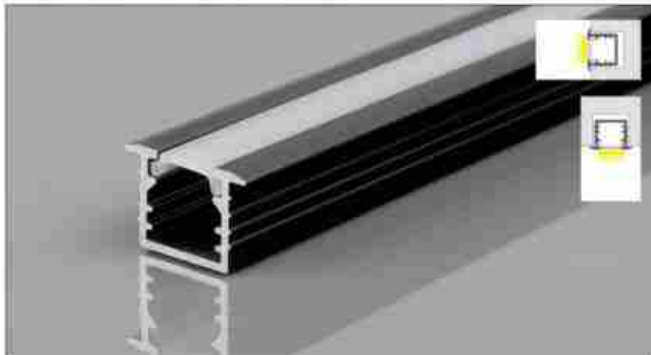
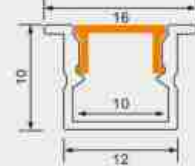

JP19

产品参数 **1311带边**

尺寸: Lx17.3x10.7mm
 表面: 氧化铝本色/喷漆 (黑色/白色/玫瑰金)
 PC罩: 乳白/黑色/亚克力磨砂可选
 适用: 10MM软灯带

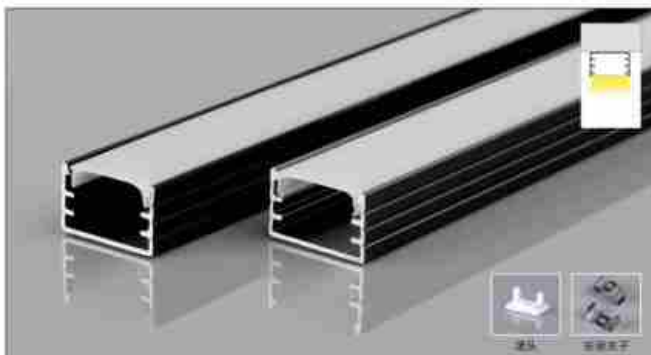
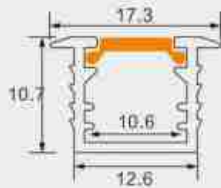

XT298

产品参数 **1509**

尺寸: Lx14.8x8.8mm
 表面: 氧化铝本色/喷漆 (黑色/白色)
 PC罩: 乳白/黑色/亚克力磨砂可选
 适用: 12MM软灯带/硬灯条

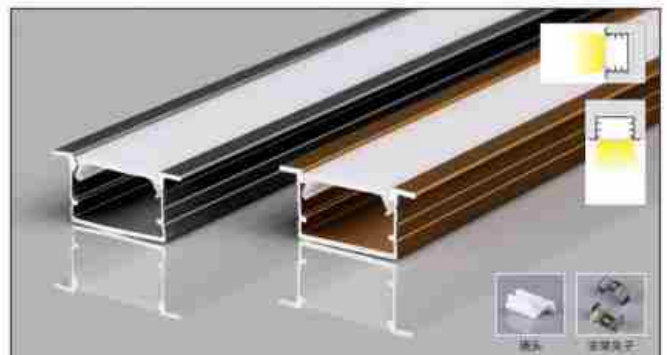
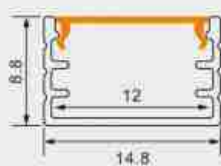

XT406

产品参数 **1509带边**

尺寸: Lx18.5x8.8mm
 表面: 氧化 (黑色/金色/铁灰色)
 PC罩: 乳白/黑色/亚克力磨砂可选
 适用: 12MM软灯带/硬灯条

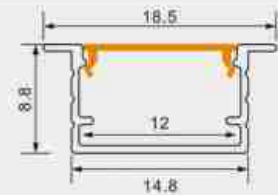



XT164

产品参数 **1707**

尺寸: Lx17.4x7mm
表面: 氧化(黑色/金色/铁灰色)
PC罩: 乳白/黑色/亚克力磨砂可选
适用: 12MM软灯带/硬灯条

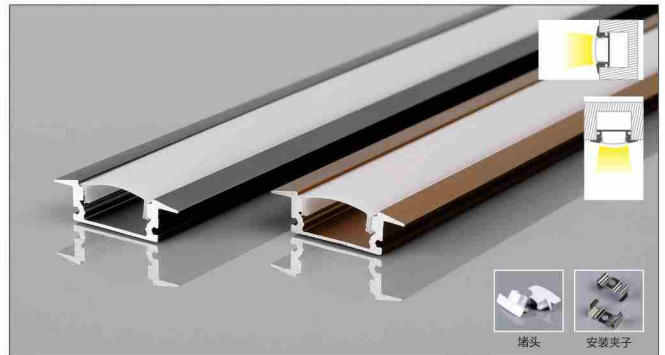
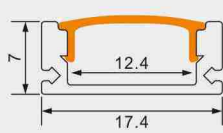

XT163

产品参数 **1707带边**

尺寸: Lx24.7x7mm
表面: 氧化(黑色/金色/铁灰色)
PC罩: 乳白/黑色/亚克力磨砂可选
适用: 12MM软灯带/硬灯条

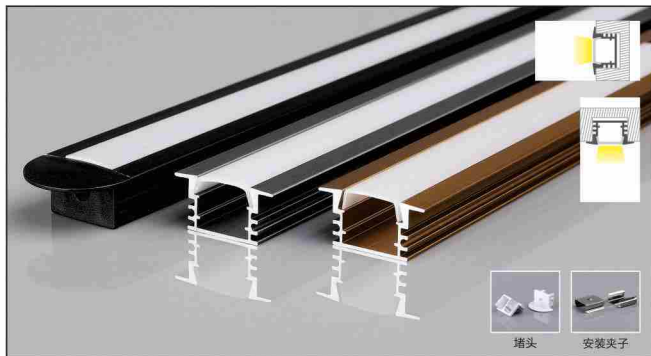
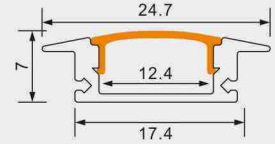

XT255

产品参数 **1712带边**

尺寸: Lx24.5x12.2mm
表面: 氧化(黑色/金色/铁灰色)
PC罩: 乳白/黑色/亚克力磨砂可选
适用: 12MM软灯带/硬灯条

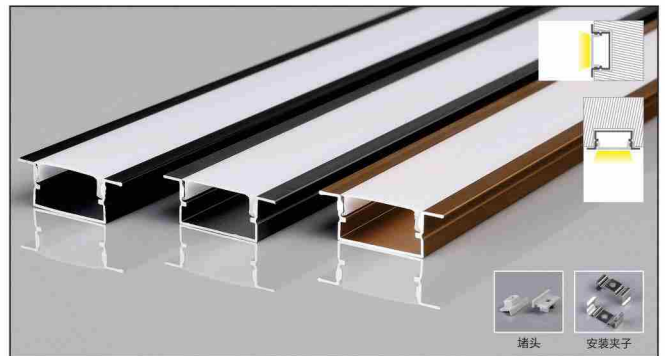
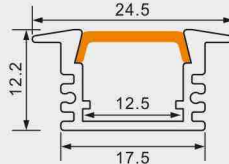

XT400

产品参数 **2010带边**

尺寸: Lx28x10mm
表面: 氧化(黑色/金色/铁灰色)
PC罩: 乳白/黑色/亚克力磨砂可选
适用: 17MM软灯带/硬灯条

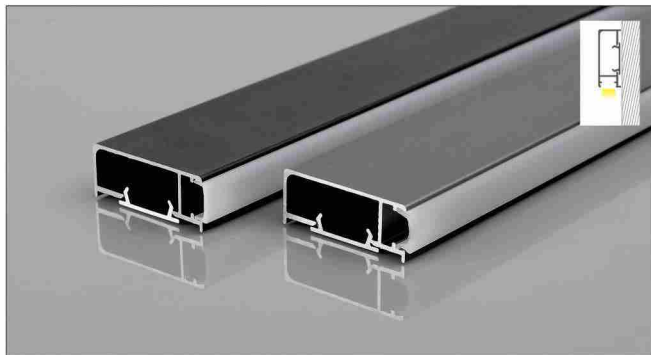
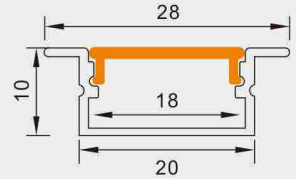

JP10JP09组合

产品参数 **1230组合**

尺寸: Lx30x12mm
表面: 氧化(黑色/金色/铁灰色)
PC罩: 乳白/黑色/亚克力磨砂可选
适用: 8MM软灯带

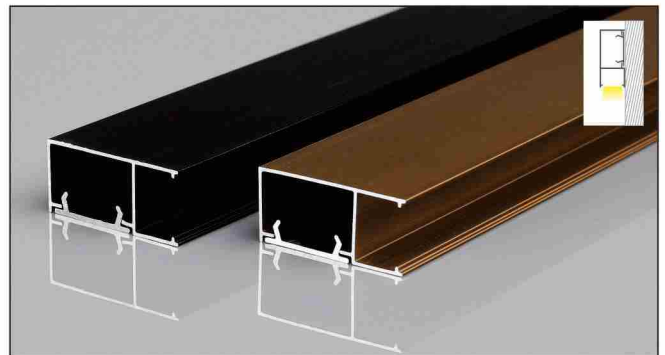
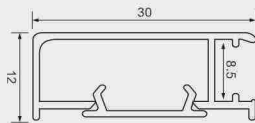

JP01JP09组合

产品参数 **1329组合**

尺寸: Lx28.5x13.2mm
表面: 氧化(黑色/金色/铁灰色)
PC罩: 乳白/黑色/亚克力磨砂可选
适用: 12MM软灯带

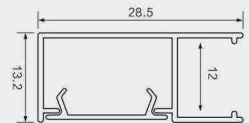

P59-P62

踢脚线/踏步灯系列

铝型材套件



XT635+636

产品参数 6016踢脚线

尺寸: Lx60x16mm
表面: 氧化 (黑色/金色/铁灰色)
PC罩: 乳白/黑色/亚克力磨砂可选
适用: 9MM软灯带

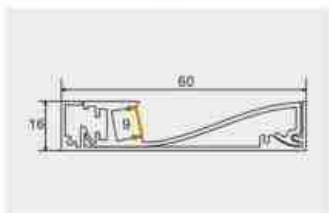

XT343+344

产品参数 8016组合踢脚线

尺寸: Lx80x16mm
表面: 氧化铝本色/喷漆 (黑色/白色/玫瑰金)
PC罩: 乳白/黑色/亚克力磨砂可选
适用: 10MM软灯带/硬灯条

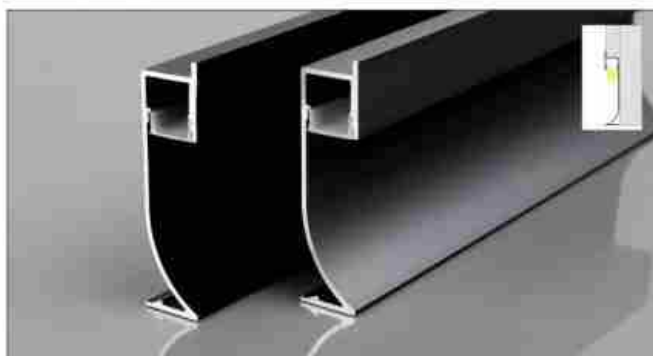
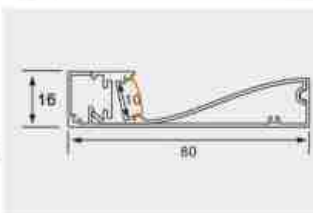

XT686

产品参数 5313踢脚线

尺寸: Lx53x13.5mm
表面: 氧化 (黑色/金色/铁灰色)
PC罩: 乳白/黑色/亚克力磨砂可选
适用: 10MM软灯带

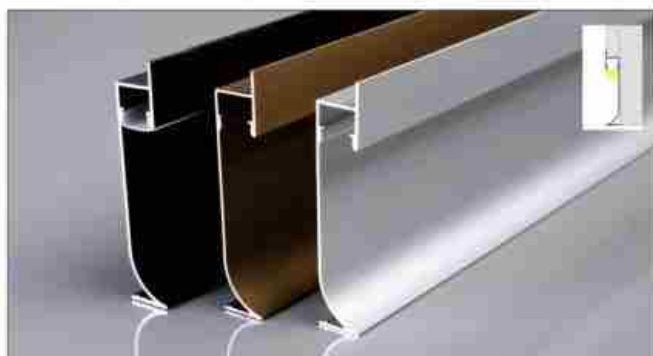
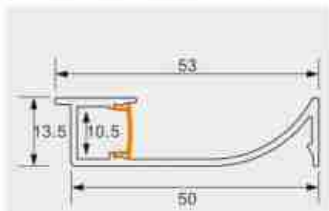

XT517

产品参数 7214踢脚线

尺寸: Lx72x14mm
表面: 氧化铝本色/喷漆 (黑色/白色/玫瑰金)
PC罩: 乳白/黑色/亚克力磨砂可选
适用: 10MM软灯带/硬灯条

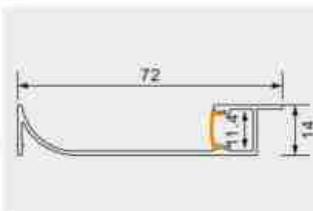

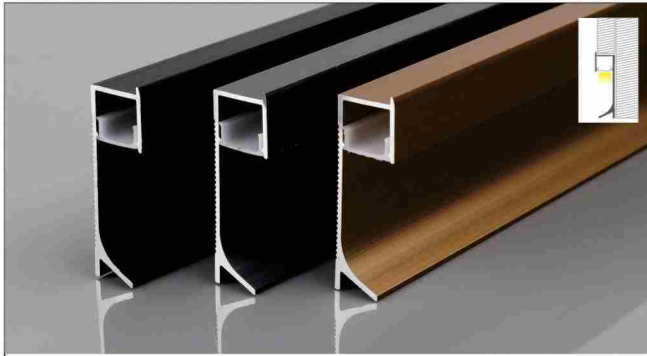

XT649

产品参数 **4013踢脚线**

尺寸: Lx42x13mm
表面: 氧化 (黑色/金色/铁灰色)
PC罩: 乳白/黑色/亚克力磨砂可选
适用: 10MM软灯带

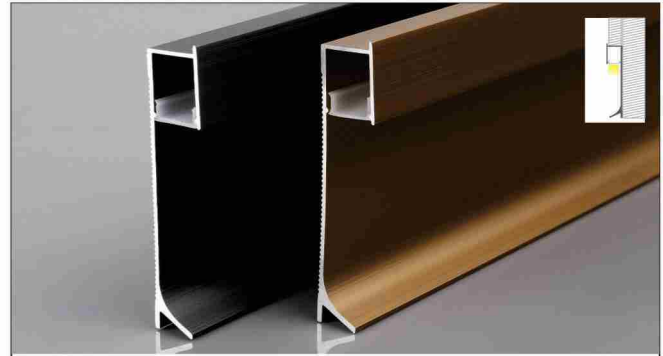
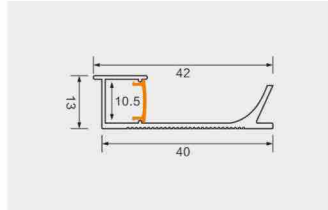

XT650

产品参数 **6013踢脚线**

尺寸: Lx61.7x13mm
表面: 氧化 (黑色/金色/铁灰色)
PC罩: 乳白/黑色/亚克力磨砂可选
适用: 10MM软灯带

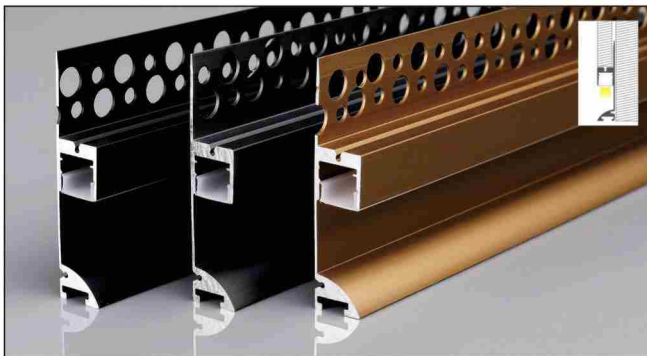
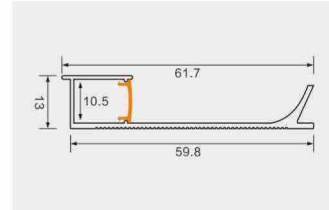

XT629

产品参数 **1360踢脚线**

尺寸: Lx60x13mm
表面: 氧化 (黑色/金色/铁灰色)
PC罩: 乳白/黑色/亚克力磨砂可选
适用: 12MM软灯带

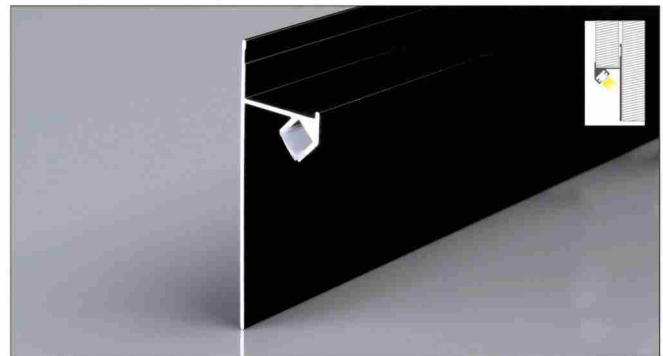

XT477小

产品参数 **6021踢脚线**

尺寸: Lx60x21mm
表面: 氧化铝本色/喷漆 (黑色/白色)
PC罩: 乳白/黑色/亚克力磨砂可选
适用: 8MM软灯带/硬灯条

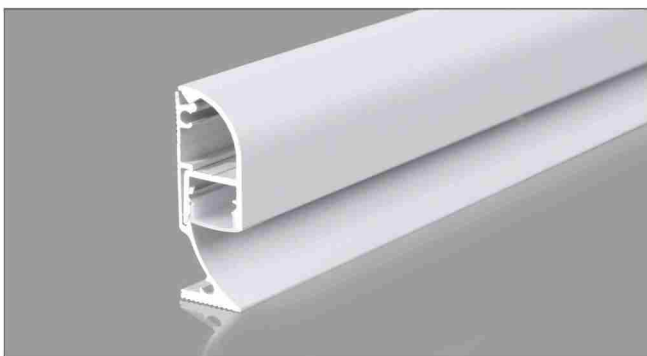
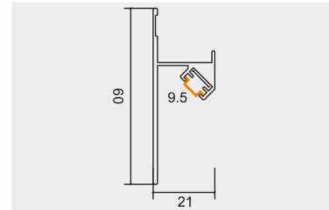

XT827+691

产品参数 **4014踢脚线**

尺寸: Lx13.5x40mm
表面: 氧化铝本色/喷漆 (黑色/白色/玫瑰金)
PC罩: 乳白/黑色/亚克力磨砂可选
适用: 10MM软灯带

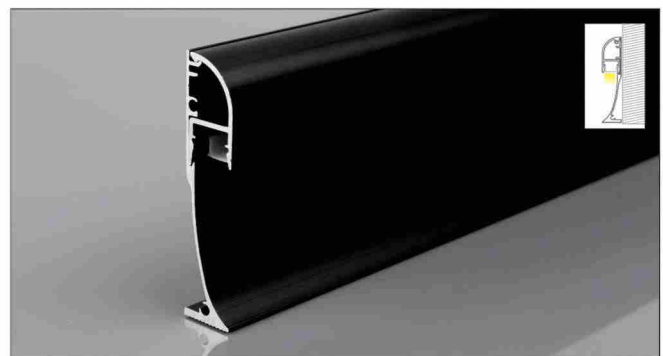
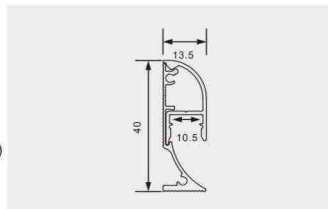

XT690+691

产品参数 **6014踢脚线**

尺寸: Lx60x14mm
表面: 氧化铝本色/喷漆 (黑色/白色/玫瑰金)
PC罩: 乳白/黑色/亚克力磨砂可选
适用: 10MM软灯带/硬灯条





XT828+691

产品参数 **8014踢脚线**

尺寸: Lx80x14mm
 表面: 氧化铝本色/喷漆 (黑色/白色/玫瑰金)
 PC罩: 乳白/黑色/亚克力磨砂可选
 适用: 10MM软灯带/硬灯条

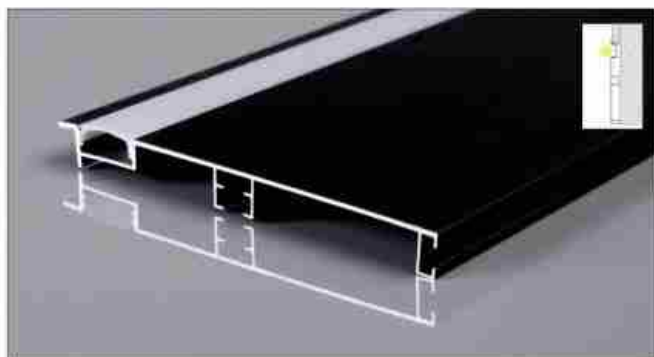

XT516

产品参数 **10010踢脚线**

尺寸: Lx100x10mm
 表面: 氧化铝本色/喷漆 (黑色/白色/玫瑰金)
 PC罩: 乳白/黑色/亚克力磨砂可选
 适用: 15MM软灯带/硬灯条

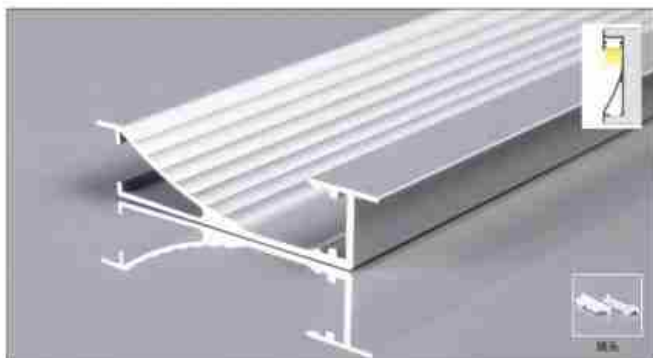
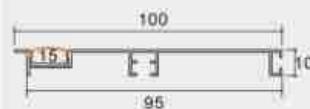

XT328

产品参数 **7116踢脚线**

尺寸: Lx71x16mm
 表面: 氧化铝本色/喷漆 (黑色/白色)
 PC罩: 乳白/黑色/亚克力磨砂可选
 适用: 12MM软灯带/硬灯条

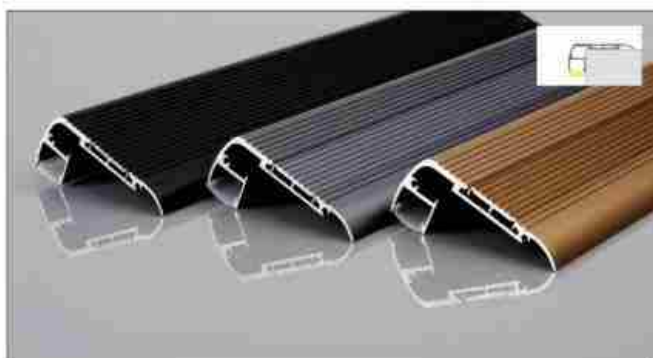
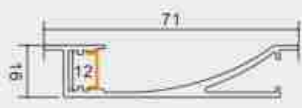

XT644+643

产品参数 **6427踏步**

尺寸: Lx64x27.5mm
 表面: 氧化 (黑色/金色/铁灰色)
 PC罩: 乳白/黑色/亚克力磨砂可选
 适用: 13MM软灯带

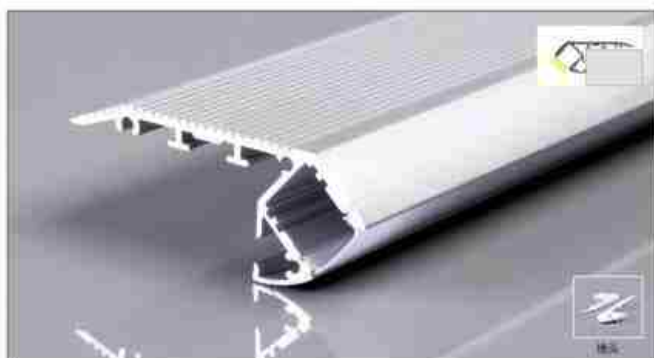
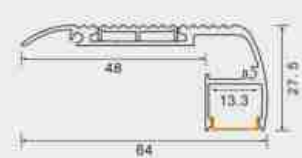

XT355

产品参数 **6626楼梯**

尺寸: Lx66x26mm
 表面: 氧化铝本色/喷漆 (黑色/白色)
 PC罩: 乳白/黑色/亚克力磨砂可选
 适用: 12MM软灯带/硬灯条

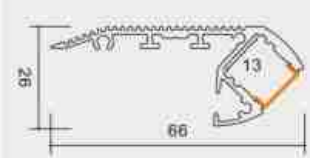



XT317

产品参数 **5527楼梯**

尺寸: Lx55x27mm
表面: 氧化铝本色/喷漆 (黑色/白色)
PC罩: 乳白/黑色/亚克力磨砂可选
适用: 12MM软灯带/硬灯条

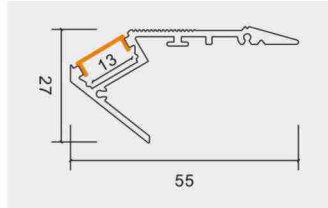

XT692

产品参数 **5327楼梯**

尺寸: Lx53x27mm
表面: 氧化铝本色/喷漆 (黑色/白色)
PC罩: 乳白/黑色/亚克力磨砂可选
适用: 12MM软灯带/硬灯条

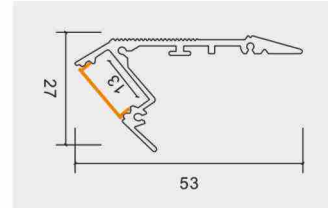

P62-P64

地踩灯

铝型材套件

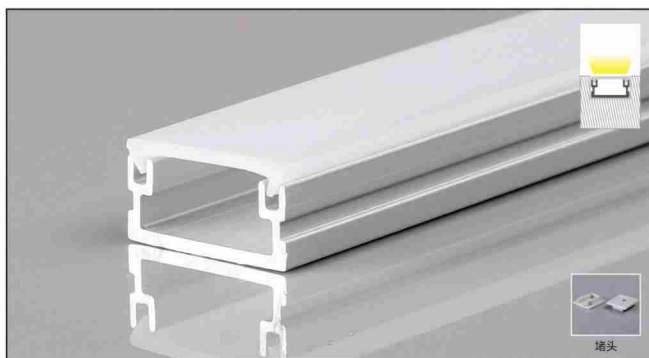

XT810

产品参数 **1607地踩**

尺寸: Lx16x8.7mm
表面: 氧化铝本色/喷漆 (黑色/白色)
PC罩: 乳白
适用: 12MM软灯带/硬灯条

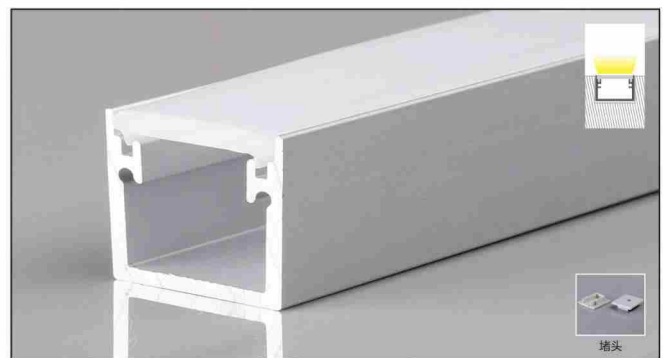
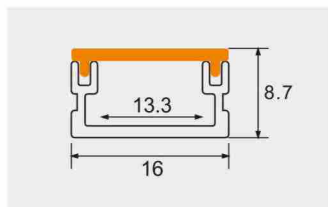

XT812

产品参数 **2015地踩**

尺寸: Lx20x15mm
表面: 氧化铝本色/喷漆 (黑色/白色)
PC罩: 乳白
适用: 16MM软灯带/硬灯条

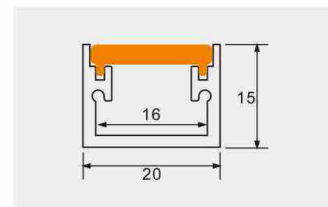



XT813

产品参数 **2020地踩**

尺寸: Lx20x20mm
 表面: 氧化铝本色/喷漆 (黑色/白色)
 PC罩: 乳白
 适用: 16MM软灯带/硬灯条

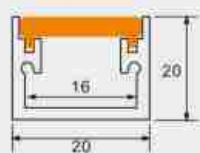

XT201

产品参数 **2211地踩**

尺寸: Lx28x11mm
 表面: 氧化铝本色/喷漆 (黑色/白色)
 PC罩: 乳白
 适用: 12MM软灯带/硬灯条

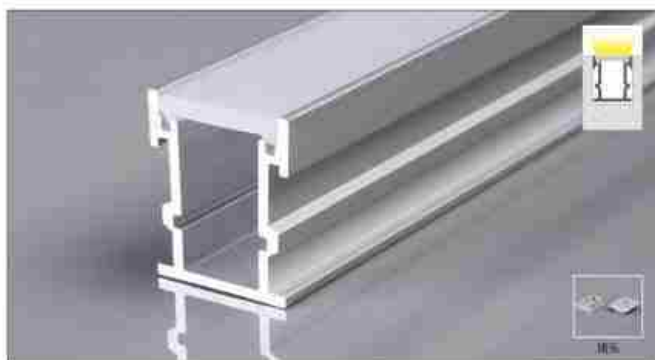
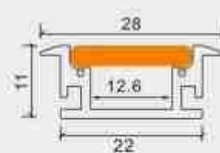

XT210

产品参数 **2226地踩**

尺寸: Lx22x26mm
 表面: 氧化铝本色/喷漆 (黑色/白色)
 PC罩: 乳白
 适用: 12MM软灯带/硬灯条

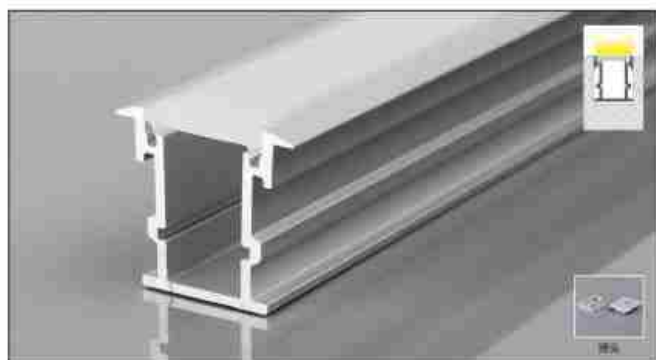
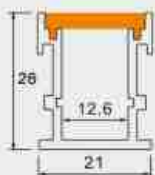

XT554

产品参数 **2226带边地踩**

尺寸: Lx30x26mm
 表面: 氧化铝本色/喷漆 (黑色/白色)
 PC罩: 乳白
 适用: 12MM软灯带/硬灯条

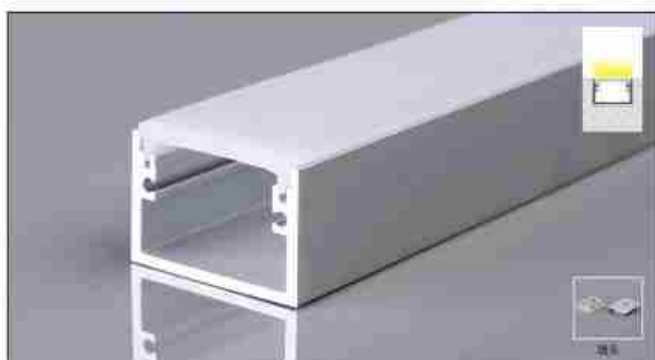
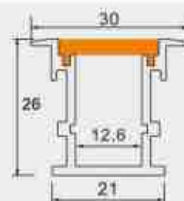

XT557

产品参数 **3020地踩**

尺寸: Lx30x20mm
 表面: 氧化铝本色/喷漆 (黑色/白色)
 PC罩: 乳白
 适用: 26MM软灯带/硬灯条

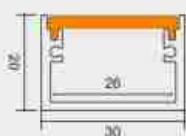

XT558

产品参数 **3020带边地踩**

尺寸: Lx41.6x20mm
 表面: 氧化铝本色/喷漆 (黑色/白色)
 PC罩: 乳白
 适用: 26MM软灯带/硬灯条

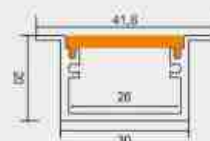

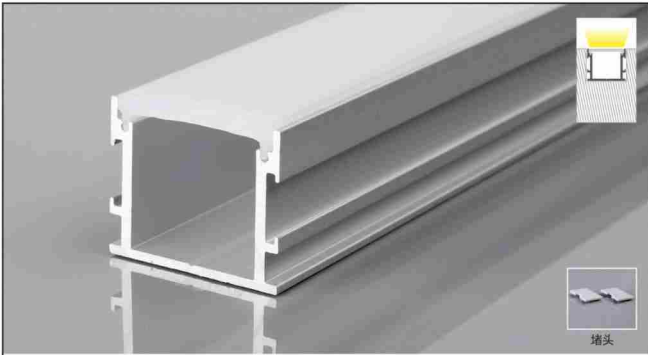

XT555

产品参数 **3025地踩**

尺寸: Lx30x25mm
表面: 氧化铝本色/喷漆 (黑色/白色)
PC罩: 乳白
适用: 21MM软灯带/硬灯条

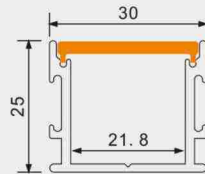

堵头

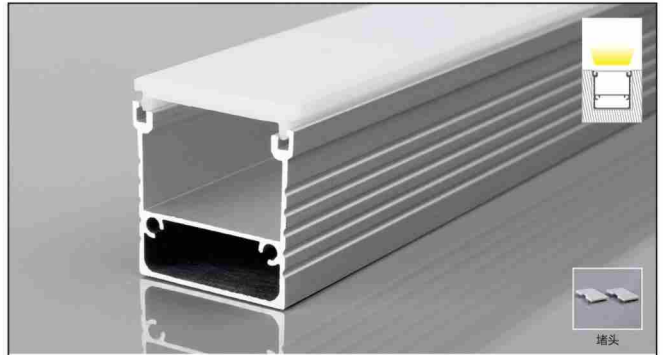

XT412

产品参数 **3435地踩**

尺寸: Lx36x35mm
表面: 氧化铝本色/喷漆 (黑色/白色)
PC罩: 乳白
适用: 31MM软灯带/硬灯条

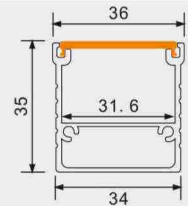

堵头

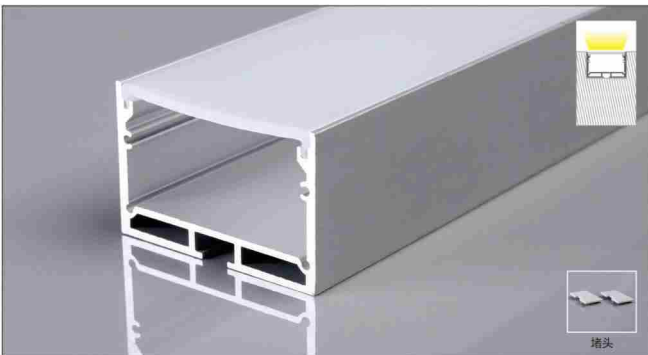

XT413

产品参数 **5033地踩**

尺寸: Lx50x33mm
表面: 氧化铝本色/喷漆 (黑色/白色)
PC罩: 乳白
适用: 43MM软灯带/硬灯条

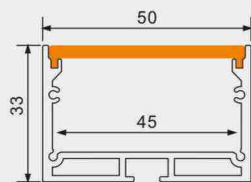

堵头

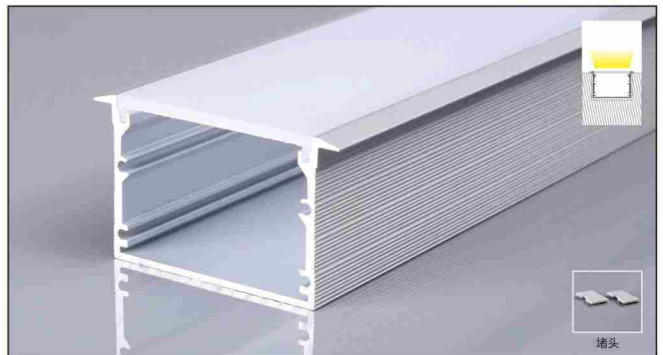

XT556

产品参数 **5035带边地踩**

尺寸: Lx50x33mm
表面: 氧化铝本色/喷漆 (黑色/白色)
PC罩: 乳白
适用: 43MM软灯带/硬灯条

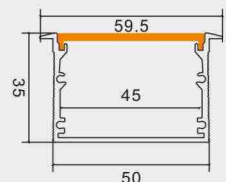

堵头

P65-P70

硅胶套管

柔性纯硅胶套管



型号:0808正发光

尺寸: Lx8x8mm
适用: 5MM软灯带



型号:1010正发光

尺寸: Lx10x10mm
适用: 6MM软灯带

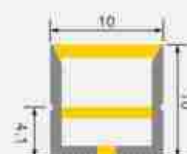

型号:1210正发光

尺寸: Lx12x10mm
适用: 8MM软灯带

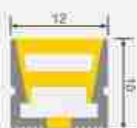

型号:1212正发光

尺寸: Lx12x12mm
适用: 8MM软灯带

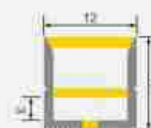

型号:1414正发光

尺寸: Lx14x14mm
适用: 8MM软灯带

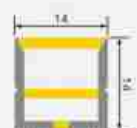

型号:1510正发光

尺寸: Lx15x10mm
适用: 8MM软灯带

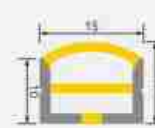

型号:1515正发光

尺寸: Lx15x15mm
适用: 8MM软灯带

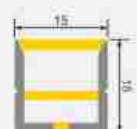

型号:1616正发光

尺寸: Lx16x16mm
适用: 10MM软灯带

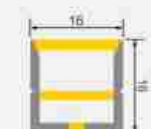

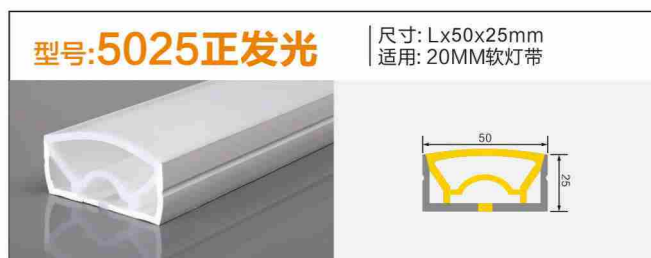
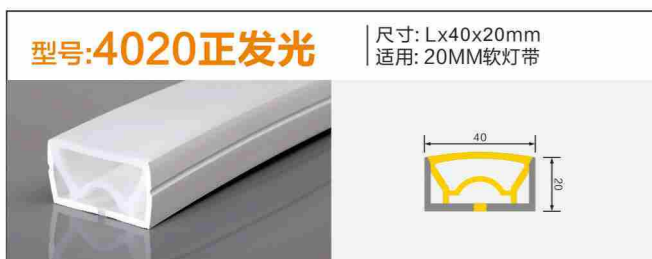
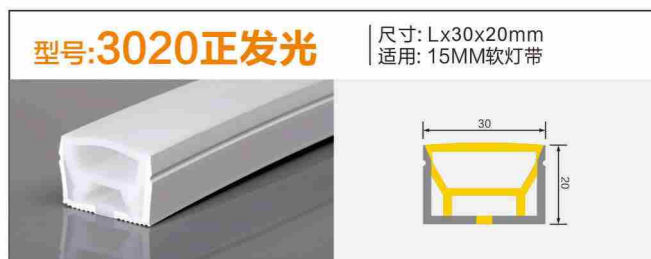
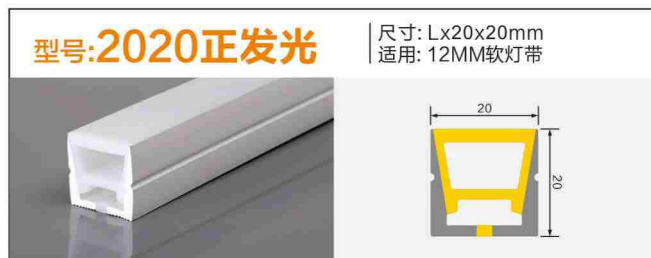
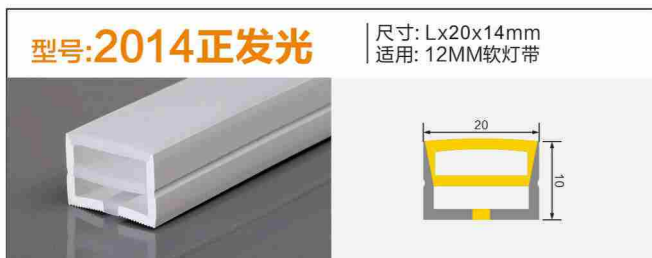
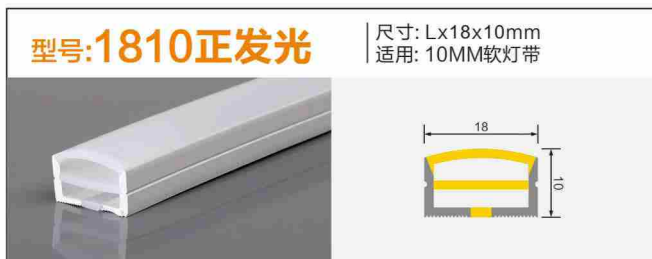

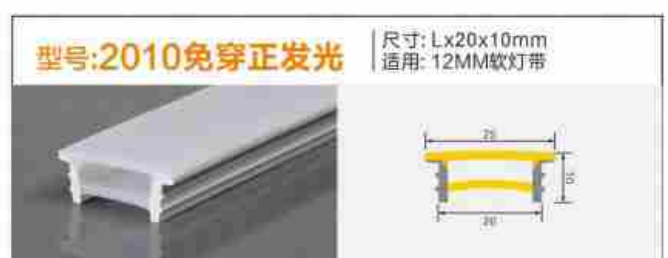
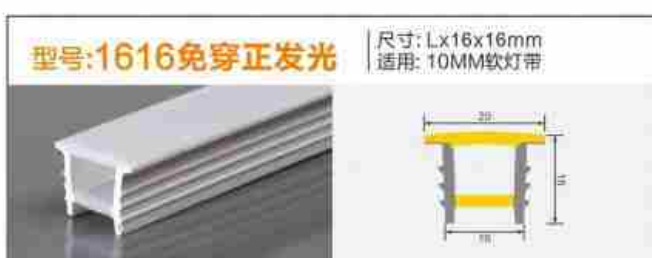
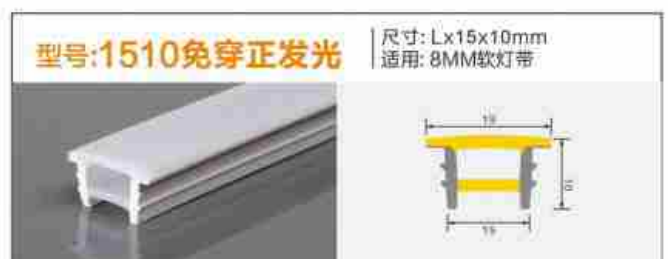
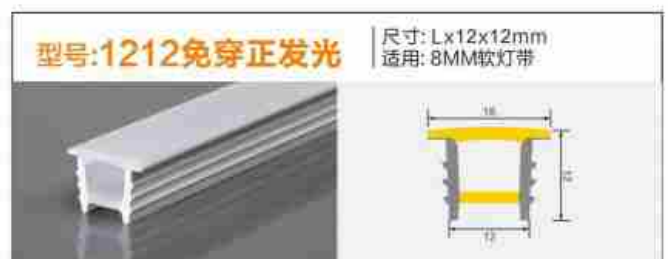
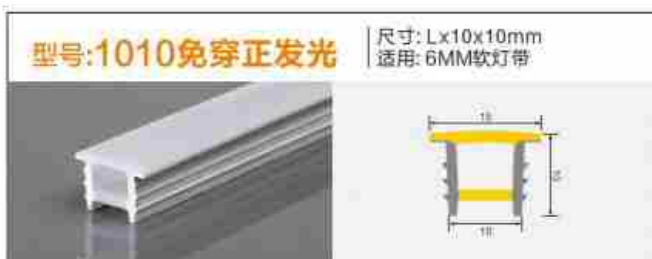
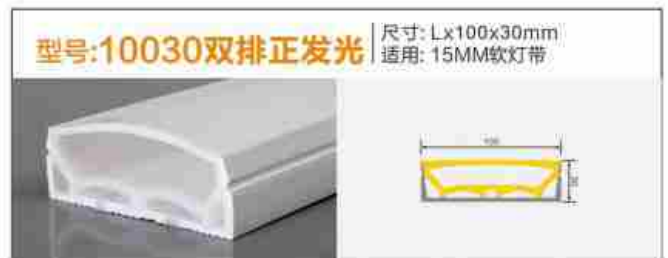
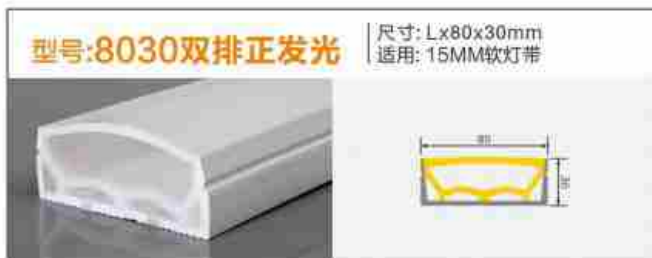
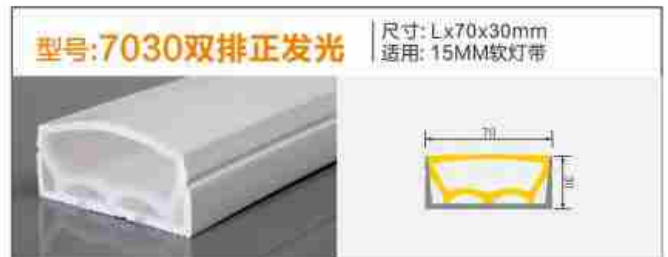
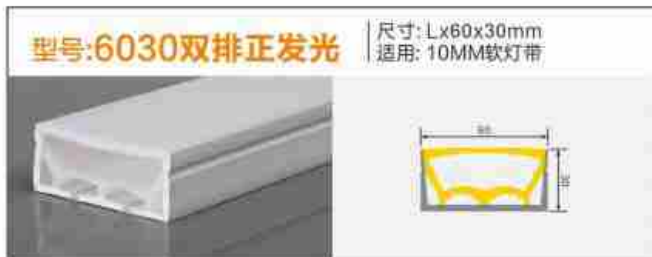
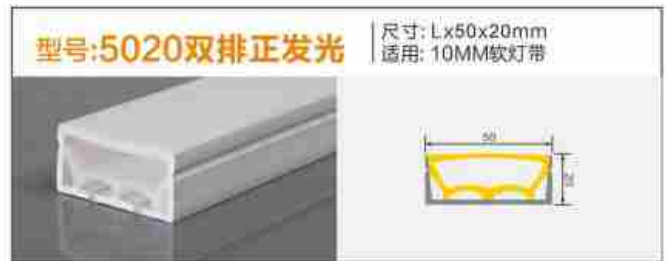
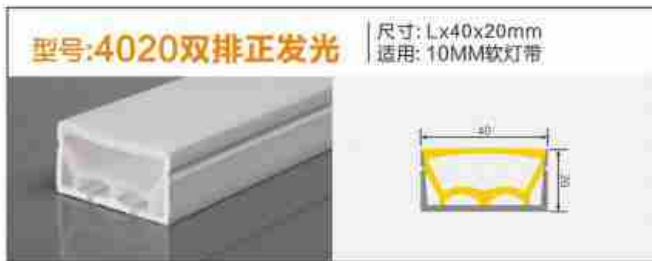

型号:2014免穿正发光 | 尺寸: Lx20x14mm
适用: 12MM软灯带

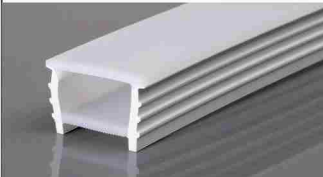
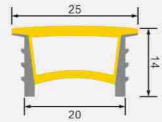
型号:2020免穿正发光 | 尺寸: Lx20x20mm
适用: 12MM软灯带

型号:2520免穿正发光 | 尺寸: Lx25x20mm
适用: 12MM软灯带

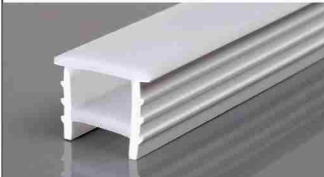
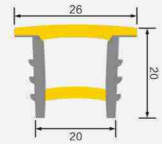
型号:3010免穿正发光 | 尺寸: Lx30x10mm
适用: 15MM软灯带

型号:3020免穿正发光 | 尺寸: Lx30x20mm
适用: 15MM软灯带

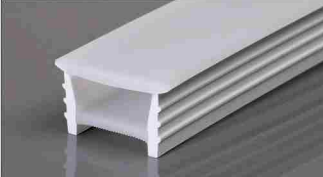
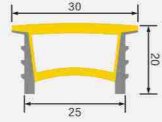
型号:4025免穿正发光 | 尺寸: Lx40x25mm
适用: 20MM软灯带

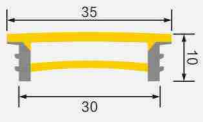
型号:2014免穿正发光 | 尺寸: Lx20x14mm
适用: 12MM软灯带

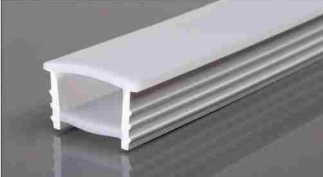
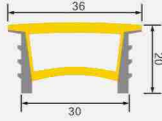
型号:2020免穿正发光 | 尺寸: Lx20x20mm
适用: 12MM软灯带

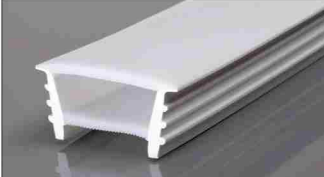
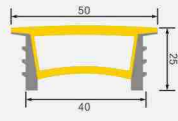
型号:2520免穿正发光 | 尺寸: Lx25x20mm
适用: 12MM软灯带

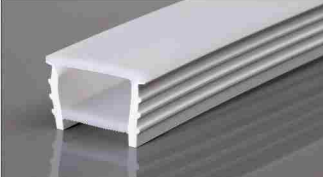
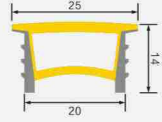
型号:3010免穿正发光 | 尺寸: Lx30x10mm
适用: 15MM软灯带

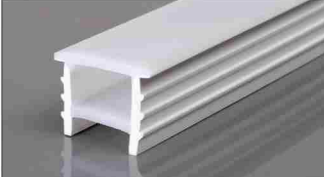
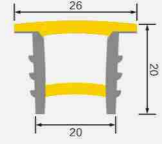
型号:3020免穿正发光 | 尺寸: Lx30x20mm
适用: 15MM软灯带

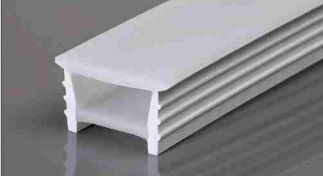
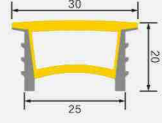
型号:4025免穿正发光 | 尺寸: Lx40x25mm
适用: 20MM软灯带

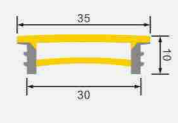
型号:5025免穿正发光 | 尺寸: Lx50x25mm
适用: 20MM软灯带

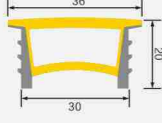
型号:0612侧发光 | 尺寸: Lx6x12mm
适用: 8MM软灯带

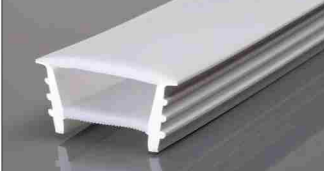
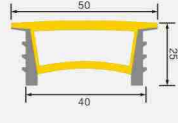
型号:1010侧发光 | 尺寸: Lx10x10mm
适用: 6MM软灯带

型号:1212侧发光 | 尺寸: Lx12x12mm
适用: 8MM软灯带

型号:0817侧发光 | 尺寸: Lx8x17mm
适用: 8MM软灯带

型号:1220侧发光 | 尺寸: Lx12x20mm
适用: 10MM软灯带

型号:1225侧发光 | 尺寸: Lx12x25mm
适用: 12MM软灯带

型号:1616侧发光 | 尺寸: Lx16x16mm
适用: 8MM软灯带

型号:2020侧发光 | 尺寸: Lx20x20mm
适用: 8MM软灯带

型号:3030侧发光 | 尺寸: Lx30x30mm
适用: 10MM软灯带

型号:V2214 | 尺寸: Lx22x14mm
适用: 6MM软灯带

型号:半圆1313 | 尺寸: Lx13x13mm
适用: 8MM软灯带

型号:圆16 | 尺寸: Lx16mm
适用: 8MM软灯带

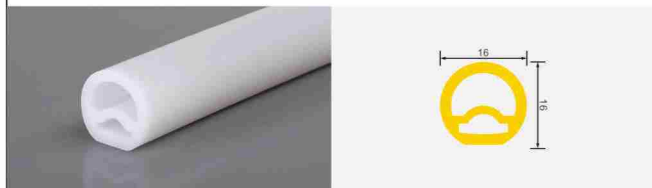

型号:圆20 | 尺寸: Lx20mm
适用: 10MM软灯带

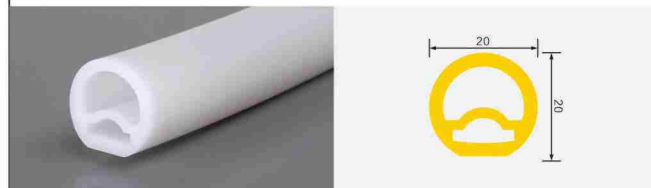

型号:2014三面发光 | 尺寸: Lx20x14mm
适用: 12MM软灯带



型号:2020三面发光 | 尺寸: Lx20x20mm
适用: 12MM软灯带



型号:线性灯小白条 | 尺寸: Lx4x8mm
适用: 5MM软灯带



型号:1010带边正发光 | 尺寸: Lx8x8mm
适用: 6MM软灯带

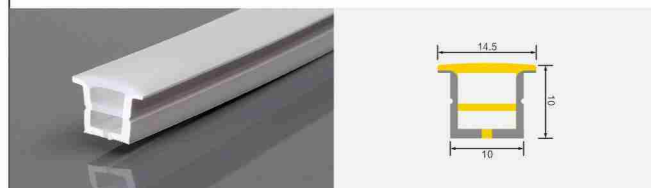

型号:1616带边正发光 | 尺寸: Lx16x16mm
适用: 10MM软灯带

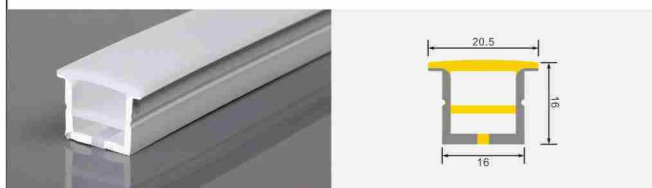

型号:2014带边正发光 | 尺寸: Lx20x14mm
适用: 12MM软灯带



型号:2020带边正发光 | 尺寸: Lx20x20mm
适用: 12MM软灯带

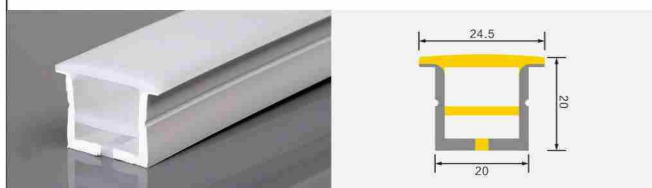

型号:3020带边正发光 | 尺寸: Lx30x20mm
适用: 15MM软灯带

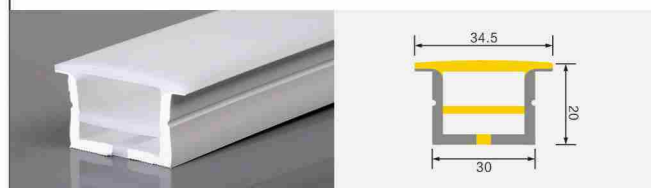

型号: 8透明硅胶管 | 尺寸: Lx8x4mm
适用: 5MM软灯带



型号:10透明硅胶管 | 尺寸: Lx10x4mm
适用: 8MM软灯带

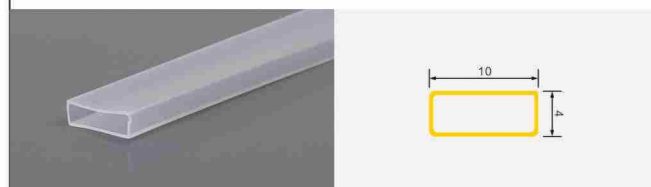

P71-P72

磁吸轨道系列

铝型材套件



WR-CX-32 预埋款

产品参数

尺寸: Lx60x46mm
表面: 氧化铝本色/喷漆 (黑色/白色)
适用: 2020 实木板轨道

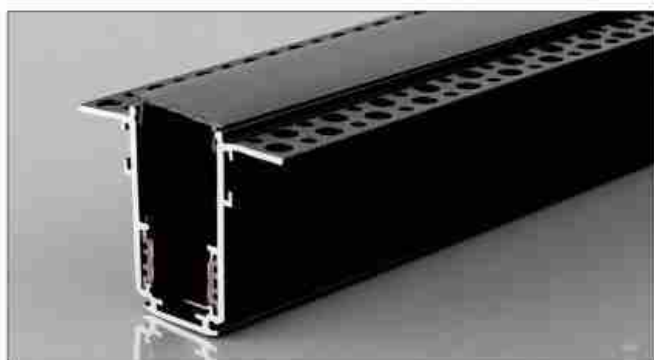
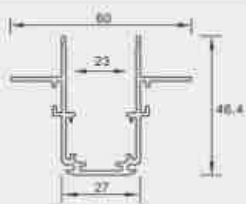

WR-CX-34 批灰款

产品参数

尺寸: Lx80x47mm
表面: 氧化铝本色/喷漆 (黑色/白色)
适用: 2020 批灰轨道

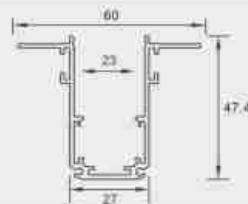

WR-CX-33 明装

产品参数

尺寸: Lx53x27mm
表面: 氧化铝本色/喷漆 (黑色/白色)
适用: 2020 明装轨道

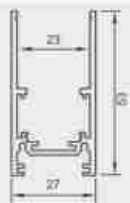

MZG-001 预埋款

产品参数

尺寸: Lx78x55mm
表面: 氧化铝本色/喷漆 (黑色/白色)
适用: 3535 实木板轨道

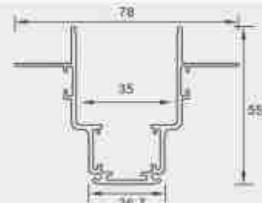

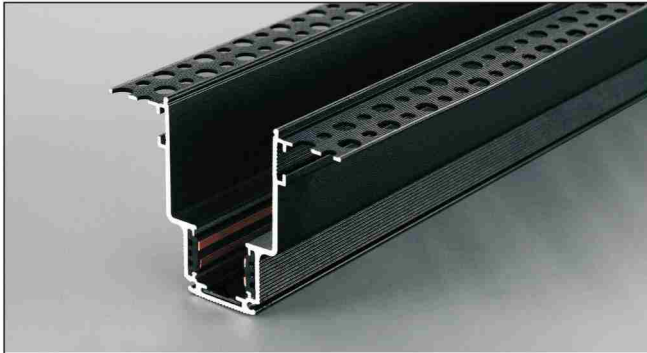

WR-CX-14批灰款

产品参数

尺寸: Lx78x55mm
表面: 氧化铝本色/喷漆 (黑色/白色)
适用: 3535批灰轨道

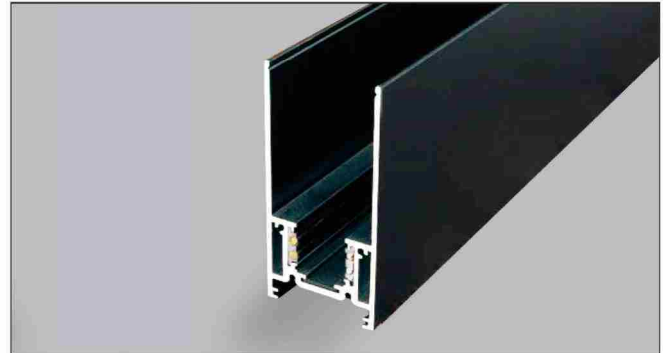
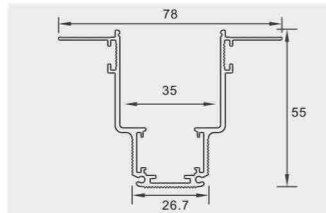

WR-CX-07明装

产品参数

尺寸: Lx79x38mm
表面: 氧化铝本色/喷漆 (黑色/白色)
适用: 3535明装轨道

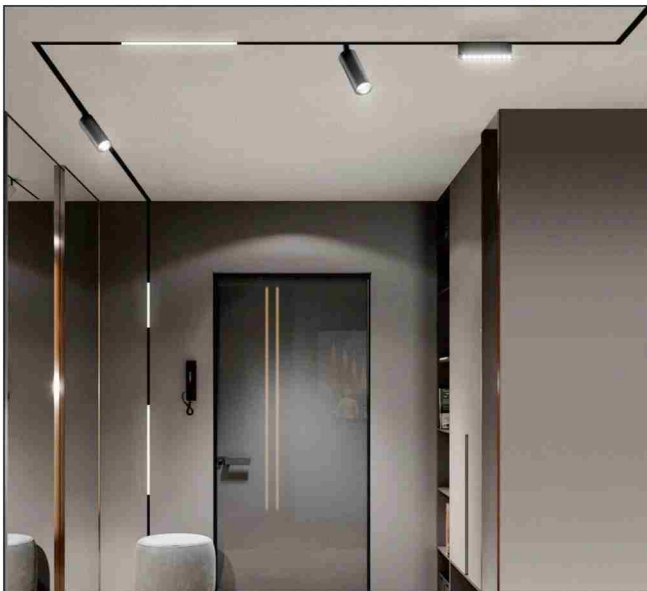
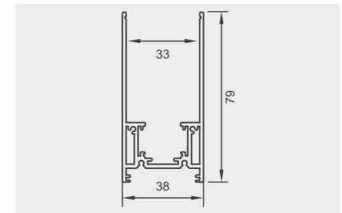

WR-CX-45预埋款

产品参数

尺寸: Lx55.8x21.1mm
表面: 氧化铝本色/喷黑 (黑色/白色)
适用: 1.6磁吸灯

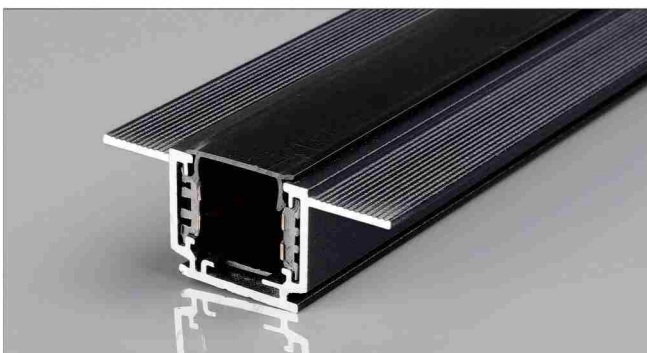
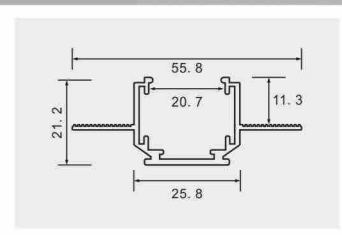

WR-CX-46批灰款

产品参数

尺寸: Lx55.6x21.1mm
表面: 氧化铝本色/喷黑 (黑色/白色)
适用: 1.6磁吸灯

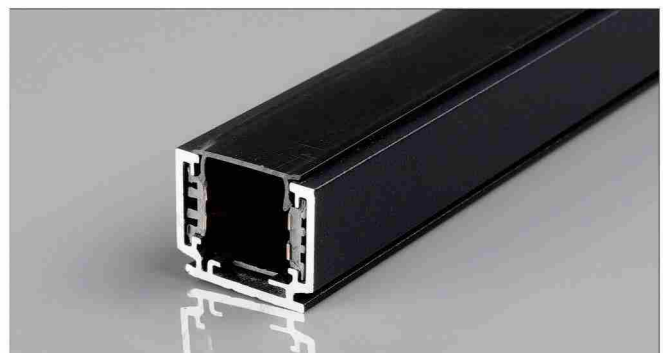
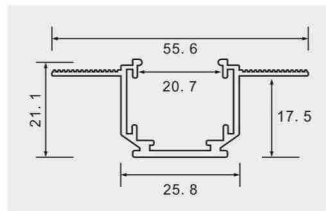

WR-CX-47明装

产品参数

尺寸: Lx25.7x24.7mm
表面: 氧化铝本色/喷黑 (黑色/白色)
适用: 1.6磁吸灯

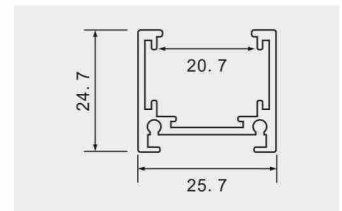



吊线



方通挂件



单边卡簧



大号卡簧



卡簧



挂件



180度直线拼接角码



140度拼接角码



120度拼接角码



90度拼接角码



120度侧面拼接角码



90度侧面拼接角码

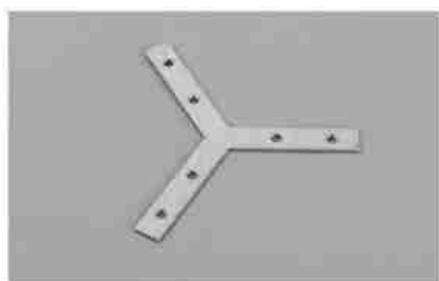

Y字拼接角码



T字拼接角码

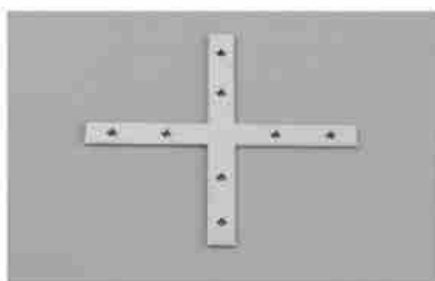

十字拼接角码



LED硬灯条光源

SMD2835

3000k / 4000k / 6000k

144珠

12mm



LED灯带

SMD2835

3000k / 4000k / 6000k

120珠

8mm



开关电源

24V / 12V

各种功率



驱动电源

隔离

各种功率

边角式安装
Corner installation

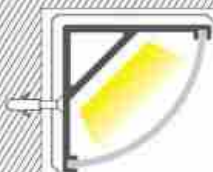

固定式安装
Fixed installation

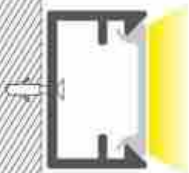

无边嵌入式安装
embedded installation

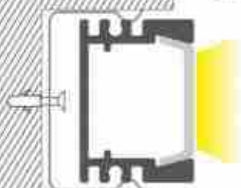

地面嵌入式安装
embedded installation

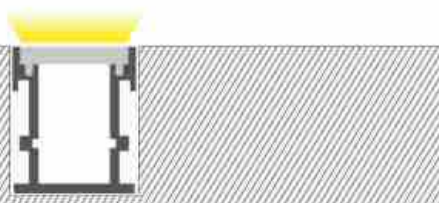

吸顶式安装
Ceiling mount

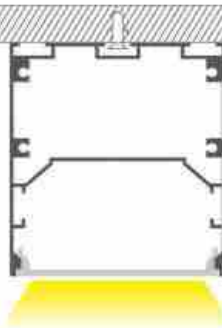

悬挂式安装
Hanging installation

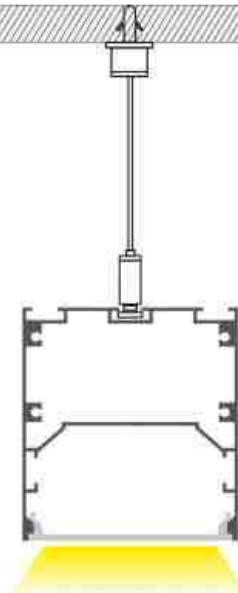

嵌入式安装
Embedded installation

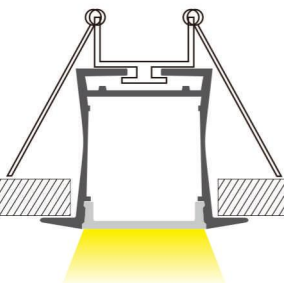

嵌入式安装
Embedded installation

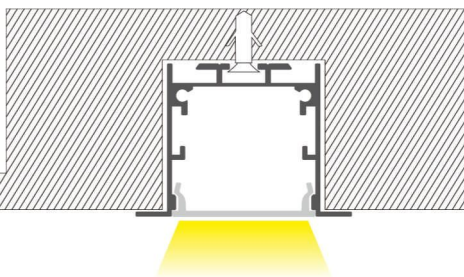

阳角嵌入式安装
Angle Embedded Installation

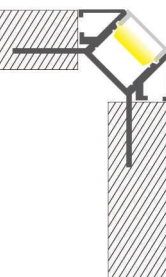

平角嵌入式安装
Flat angle flush mount

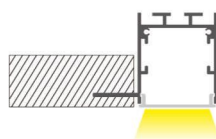

阴角嵌入式安装
Inner angle embedded installation

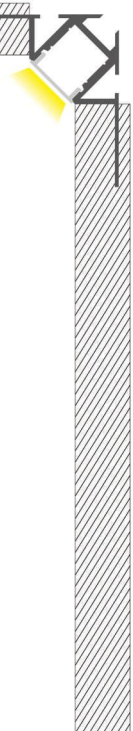

固定式安装
Fixed installation

